

for perfect connections



2024

FIYAT LİSTESİ

www.sutemelektrik.com



Sutem Elektrik fiyat listesindeki yazım hatası ve baskı hatalarından dolayı sorumlu değildir.
Sutem Elektrik fiyat listesinde yayınlanmış olduğumuz teknik özellik ve çizimleri ürün yenileme, değiştirme,
döviz ve hammadde artışlarından dolayı meydana gelebilecek fiyat artışlarını hiçbir uyarıda bulunmaksızın
Sutem Elektrik fiyat listesine yansıtma hakkına sahiptir.



Günümüzde ki gelişen teknoloji üretim, pazarlama ve satış alanlarında firmalarının rekabetlerinin hızlı ve hatasız aynı zamanda da yenilikçi olmalarını zorunlu hale getirmiştir. Bu rekabete ortak olabilmek için tüm firmalar kıyasıya mücadele haline girmiş ve optimum kalite amacı ile en iyi malzemeyi en iyi fiyata ve tam istenilen zamanda teslim etmek için gerekli olan insan ve teknoloji yatırımlarında bulunmuşlardır.

Bu işlemler için kullanılan bilgisayar destekli otomasyon programlarını, nitelikli insan gücü ile destekleyerek, güler yüzlü hizmet vermek ve müşteri memnuniyetini sağlamak esas amacımız olarak; 2007 yılında İstanbul 'da kurulmuş olan şirketimiz sahip olduğu entellektüel bilgilerini sizlere daha iyi hizmet vermek için kullanmakta, hızlı bir şekilde gelişen teknolojinin her daim takipçisi olarak gerekli teknolojik yatırımlarına devam etmelidir.

Sahip olduğumuz güven ve bilgi ile piyasada fark yaratmak ve değerli müşterilerimizin yararına olan tüm yenilikleri sizlere sunmayı görev bilen bizler, güveniniz ve desteğiniz ile geleceğe olan yürüyüşümüzü aynı kararlılıkla devam ettirmekte ve her zaman sizleri yanımızda görmekten mutluluk duymaktayız.



Today's developing technology in the fields of production, marketing and sales is rapidly increasing the competition of companies. and error-free and at the same time innovative to be a part of this competition . for this purpose , all companies have entered into a fierce struggle and use the best material with the aim of optimum quality. the people and technology needed to deliver at the right price and on time have invested.

Computer-aided automation programs used for these processes, with qualified manpower. Our main aim is to provide friendly service and customer satisfaction by supporting; Our company, which was established in İstanbul in 2007, can better provide you with its intellectual knowledge . to serve, as a follower of the rapidly developing technology. continues its technological investments.

To make a difference in the market with the trust and knowledge we have and to do all the work for the benefit of our valued customers . We who take it as our duty to present innovations to you, continue our walk to the future with your trust and support. We continue with the same determination and we are always happy to see you by our side.



SUTEM®

for perfect connections

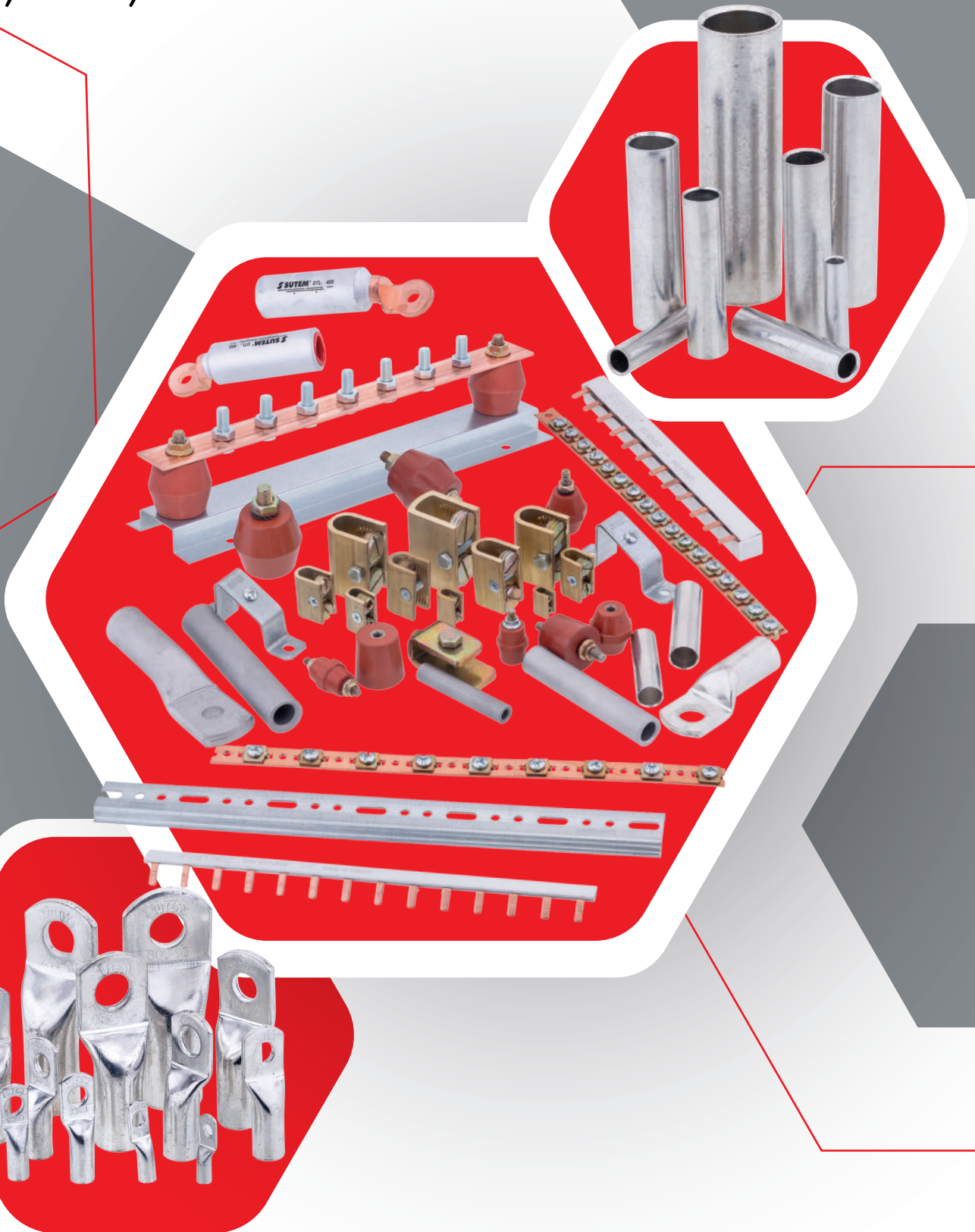

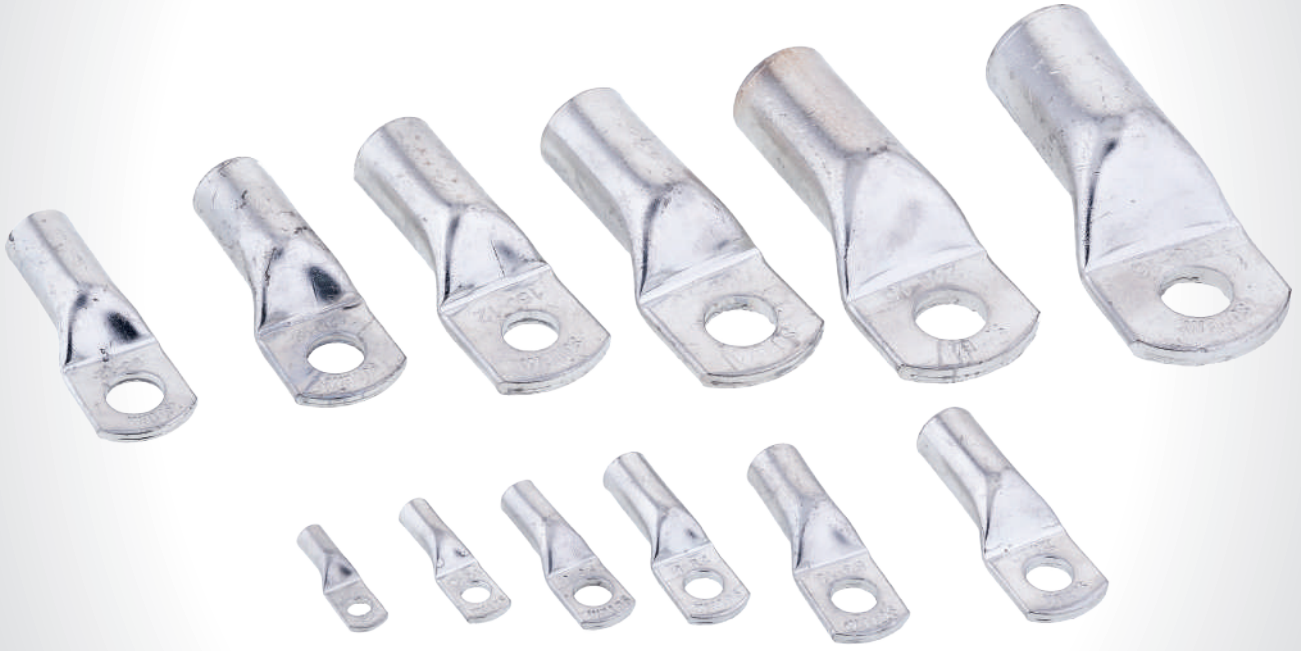

BAKIR KABLO PABUCLARI EKONOMİK TİP COPPER CABLE LUGS ECONOMIC TYPE

Gözde yalıtımsız düz boru kablo pabuçları tip tasarımı.
Soket: DIN EN 13600'e göre bakır Yüzey kalay kaplı.
Sıcaklık aralığı: +120° C'ye kadar.

Popular non-insulated straight tube cable lugs type design.
Socket: copper according to DIN EN 13600. Surface tin-plated.
Temperature range: up to + 120°C

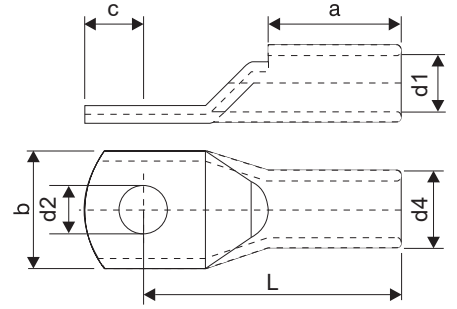

KOD CODE	b	d2	L	c	L+c	a	d1	d4	ÜRÜN AĞIRLIĞI PRODUCT WEIGHT	KUTU AĞIRLIĞI BOX WEIGHT	KUTU ADET BOX PİECES	FİYAT (TÜRK LİRASI)
STM-16 E	10,5	M6	24,0	7,5	31,5	12,5	5,6	6,9	3,25g	~1,7kg	500	11,00
STM-16 E	12,5	M8	23,5	8,5	32,0	12,5	5,6	6,9	3,15g	~1,6kg	500	11,00
STM-25 E	13,0	M6	31,0	8,5	39,5	17,5	7,0	8,8	6,50g	~2,3kg	350	17,85
STM-25 E	13,0	M8	31,0	8,5	39,5	17,5	7,0	8,8	6,50g	~2,3kg	350	17,85
STM-35 E	15,5	M6	34,0	9,5	43,5	17,5	8,2	10,0	9,20g	~1,9kg	200	28,30
STM-35 E	15,5	M8	34,0	9,5	43,5	17,5	8,2	10,0	9,20g	~1,9kg	200	28,30
STM-50 E	18,0	M8	40,5	11,0	51,5	21,0	10,2	11,8	11,90g	~1,8kg	150	33,75
STM-50 E	18,0	M10	40,5	11,0	51,5	21,0	10,2	11,8	11,90g	~1,8kg	150	33,75
STM-70 E	20,5	M8	44,0	12,0	56,0	24,0	11,7	13,9	20,45g	~2,1kg	100	51,50
STM-70 E	20,5	M10	44,0	12,0	56,0	24,0	11,7	13,9	20,45g	~2,1kg	100	51,50
STM-95 E	23,5	M10	48,5	12,5	61,0	25,5	13,6	15,6	22,85g	~1,8kg	75	56,00
STM-95 E	23,5	M12	48,5	12,5	61,0	25,5	13,6	15,6	22,85g	~1,8kg	75	56,00
STM-120 E	26,5	M10	55,0	14,0	69,0	30,0	15,5	17,7	33,25g	~1,7kg	50	78,50
STM-120 E	26,5	M12	55,0	14,0	69,0	30,0	15,5	17,7	33,25g	~1,7kg	50	78,50
STM-150 E	29,5	M10	61,5	16,5	77,5	37,0	16,7	19,7	54,95g	~2,3kg	40	118,00
STM-150 E	29,5	M12	61,5	16,5	77,5	37,0	16,7	19,7	54,95g	~2,3kg	40	118,00
STM-185 E	32,5	M12	67,5	16,5	84,5	41,0	18,8	21,9	68,20g	~2,1kg	30	141,85
STM-185 E	32,5	M16	67,5	16,5	84,5	41,0	18,8	21,9	68,20g	~2,1kg	30	141,85
STM-240 E	37,0	M12	74,5	16,5	91,0	43,0	21,2	25,0	108,10g	~2,8kg	25	215,00
STM-240 E	37,0	M16	74,5	16,5	91,0	43,0	21,2	25,0	108,10g	~2,8kg	25	215,00



BAKIR KABLO PABUCLARI STANDART TİP

COPPER CABLE LUGS STANDARD TYPE

Gözde yalıtımsız düz boru kablo pabuçları tip tasarımı.
Soket: DIN EN 13600'e göre bakır yüzey kalay kaplı.
Sıcaklık aralığı: +120° C'ye kadar.

Popular non-insulated straight tube cable lugs type design.
Socket: copper according to DIN EN 13600. Surface tin-plated.
Temperature range: up to + 120°C

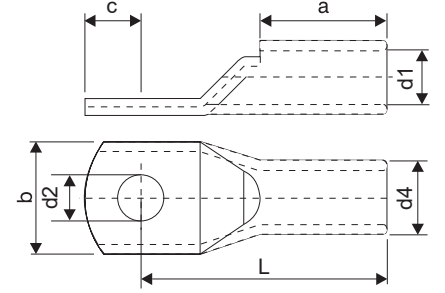

Özel metrik ürünler için lütfen stok bilgisi isteyiniz.
for special products, please request stock information.

KOD CODE	b	d2	L	c	L+c	a	d1	d4	ÜRÜN AĞIRLIĞI PRODUCT WEIGHT	KUTU AĞIRLIĞI BOX WEIGHT	KUTU ADET BOX PİECES	FİYAT (TÜRK LİRASI)
STM-6 S	8,5	M5	20,0	6,0	26,0	10,5	4,0	5,5	2,35g	~2,4 kg	1000	10,50
STM-10 S	9,5	M5	22,5	7,0	29,5	12,0	5,0	6,5	3,25g	~2,7kg	800	12,30
STM-10 S	11,0	M6	23,0	6,5	29,5	12,0	5,0	6,5	3,10g	~2,5kg	800	12,75
STM-10 S	13,0	M8	22,5	7,0	29,5	12,0	5,0	6,5	2,90g	~2,4kg	800	13,00
STM-16 S	11,0	M6	26,5	7,5	34,0	15,0	5,7	7,7	5,70g	~2,9kg	500	16,00
STM-16 S	13,5	M8	26,0	8,0	34,0	15,0	5,7	7,7	5,30g	~2,7kg	500	16,50
STM-16 S	14,5	M10	26,0	8,0	34,0	15,0	5,7	7,7	5,00g	~2,6kg	500	17,00
STM-25 S	13,5	M6	30,5	9,0	39,5	17,0	7,0	9,5	10,55g	~3,8kg	350	26,00
STM-25 S	13,5	M8	30,5	9,0	39,5	17,0	7,0	9,5	10,10g	~3,6kg	350	26,00
STM-25 S	15,5	M10	30,5	8,5	39,5	17,0	7,0	9,5	9,65g	~3,4kg	350	26,50
STM-35 S	16,0	M6	36,0	9,5	45,5	19,0	8,5	11,0	14,60g	~3,0kg	200	37,20
STM-35 S	16,0	M8	36,0	9,5	45,5	19,0	8,5	11,0	14,05g	~2,9kg	200	37,20
STM-35 S	17,0	M10	36,0	9,5	45,5	19,0	8,5	11,0	13,20g	~2,7kg	200	38,00
STM-35 S	19,0	M12	36,5	11,5	48,0	19,0	8,5	11,0	13,60g	~2,8kg	200	39,00
STM-50 S	18,5	M6	40,0	11,5	51,5	20,5	10,0	13,0	24,00g	~3,7kg	150	52,00
STM-50 S	18,5	M8	40,0	11,5	51,5	20,5	10,0	13,0	23,25g	~3,5kg	150	52,00
STM-50 S	18,5	M10	40,0	11,5	51,5	20,5	10,0	13,0	22,35g	~3,4kg	150	52,00
STM-50 S	21,5	M12	42,0	11,5	53,5	20,5	10,0	13,0	22,00g	~3,4kg	150	53,00
STM-50 S	20,5	M14	40,0	11,5	51,5	20,5	10,0	13,0	21,80g	~3,9kg	150	54,00
STM-70 S	21,0	M8	44,0	12,0	56,0	24,5	11,5	14,5	28,65g	~2,9kg	100	66,00
STM-70 S	21,0	M10	44,0	12,0	56,0	24,5	11,5	14,5	28,25g	~2,9kg	100	66,00
STM-70 S	21,0	M12	44,0	12,0	56,0	24,5	11,5	14,5	26,38g	~2,7kg	100	67,00
STM-70 S	21,0	M14	47,0	10,5	57,5	24,0	11,5	14,5	26,00g	~2,7kg	100	68,00
STM-95 S	24,0	M8	50,5	12,5	63,0	27,5	13,5	16,5	38,00g	~2,9kg	75	80,00
STM-95 S	24,0	M10	50,5	12,5	63,0	27,5	13,5	16,5	37,00g	~2,8kg	75	80,00
STM-95 S	24,0	M12	50,5	12,5	63,0	27,5	13,5	16,5	36,00g	~2,8kg	75	80,00
STM-95 S	24,0	M14	51,5	12,5	64,0	27,5	13,5	16,5	34,85g	~2,7kg	75	81,00
STM-95 S	26,0	M16	51,0	14,0	65,0	27,5	13,5	16,5	34,00g	~2,6kg	75	82,00

BAKIR KABLO PABUCLARI STANDART TİP

COPPER CABLE LUGS STANDARD TYPE

Gözde yalıtımsız düz boru kablo pabuçları tip tasarımı.
Soket: DIN EN 13600'e göre bakır yüzey kalay kaplı.
Sıcaklık aralığı: +120° C'ye kadar.

Popular non-insulated straight tube cable lugs type design.
Socket: copper according to DIN EN 13600. Surface tin-plated.
Temperature range: up to + 120°C

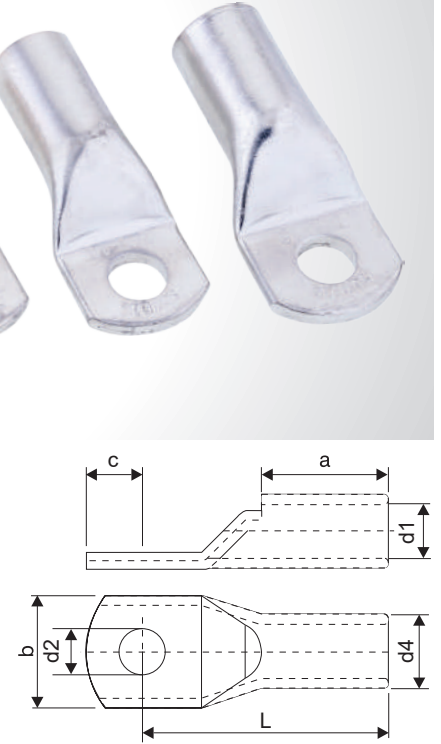

Özel metrik ürünler için lütfen stok bilgisi isteyiniz.
for special products, please request stock information.

KOD CODE	b	d2	L	c	L+c	a	d1	d4	ÜRÜN AĞIRLIĞI PRODUCT WEIGHT	KUTU AĞIRLIĞI BOX WEIGHT	KUTU ADET BOX PİECES	FİYAT (TÜRK LİRASI)
STM-120 S	26,5	M8	55,0	14,0	69,0	30,0	15,5	19,0	56,30g	~2,9kg	50	115,50
STM-120 S	26,5	M10	55,0	14,0	69,0	30,0	15,5	19,0	55,25g	~2,8kg	50	115,50
STM-120 S	26,5	M12	55,0	14,0	69,0	30,0	15,5	19,0	54,10g	~2,8kg	50	115,50
STM-120 S	26,5	M14	55,0	14,0	69,0	30,0	15,5	19,0	54,00g	~2,8kg	50	116,50
STM-120 S	26,5	M16	55,5	14,5	69,5	30,5	15,5	19,0	53,80g	~2,8kg	50	117,50
STM-150 S	30,5	M10	61,5	16,0	77,5	33,0	16,5	21,0	84,50g	~3,4kg	40	175,00
STM-150 S	30,5	M12	61,5	16,0	77,5	33,0	16,5	21,0	84,00g	~3,4kg	40	175,00
STM-150 S	30,5	M14	61,5	16,0	77,5	33,0	16,5	21,0	83,30g	~3,4kg	40	176,00
STM-150 S	30,5	M16	61,5	16,0	77,5	33,0	16,5	21,0	81,00g	~3,3kg	40	177,00
STM-185 S	33,5	M10	68,0	16,5	84,5	37,5	18,5	23,0	103,20g	~3,2kg	30	212,30
STM-185 S	33,5	M12	68,0	16,5	84,5	37,5	18,5	23,0	102,50g	~3,1kg	30	212,30
STM-185 S	33,5	M14	68,0	16,5	84,5	37,5	18,5	23,0	101,00g	~3,1kg	30	212,30
STM-185 S	33,5	M16	68,0	16,5	84,5	37,5	18,5	23,0	98,30g	~3,0kg	30	212,30
STM-240 S	38,0	M10	76,0	17,0	93,0	41,5	21,0	26,0	141,66g	~3,6kg	25	274,00
STM-240 S	38,0	M12	76,0	17,0	93,0	41,5	21,0	26,0	139,83g	~3,6kg	25	274,00
STM-240 S	38,0	M14	76,0	17,0	93,0	41,5	21,0	26,0	139,00g	~3,5kg	25	274,00
STM-240 S	38,0	M16	76,0	17,0	93,0	41,5	21,0	26,0	136,10g	~3,5kg	25	274,00
STM-300 S	41,0	M12	79,0	18,0	98,0	44,0	23,5	28,5	172,60g	~3,5kg	20	324,20
STM-300 S	41,0	M14	79,0	18,0	98,0	44,0	23,5	28,5	172,60g	~3,5kg	20	324,20
STM-300 S	41,0	M16	79,0	18,0	98,0	44,0	23,5	28,5	172,60g	~3,5kg	20	324,20
STM-400 S	48,0	M14	79,0	25,0	110,0	50,0	27,0	33,0	256,60g	~3,9kg	10	381,00
STM-400 S	48,0	M16	79,0	25,0	110,0	50,0	27,0	33,0	256,25g	~3,9kg	10	381,00
STM-400 S	48,0	M20	79,0	25,0	110,0	50,0	27,0	33,0	249,00g	~3,8kg	10	381,00



BAKIR KABLO PABUCLARI (DIN NORM) COPPER CABLE LUGS (DIN NORM)

Gözde yalıtımsız düz boru kablo pabuçları tip tasarımı.
Soket: DIN EN 13600'e göre bakır Yüzey kalay kaplı.
Sıcaklık aralığı: +120° C'ye kadar.

Popular non-insulated straight tube cable lugs type design.
Socket: copper according to DIN EN 13600. Surface tin-plated.
Temperature range: up to + 120°C

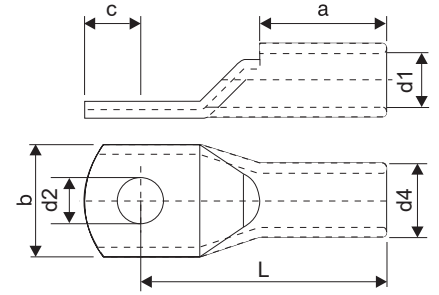

KOD CODE	b	d2	L	c	L+c	a	d1	d4	KUTU ADET BOX PIECES	FİYAT (TÜRK LİRASI)
STM-16 D	13,0	M6	36,0	7,5	43,5	20,0	5,5	8,5	200	28,75
STM-16 D	13,0	M8	36,0	10,0	46,0	20,0	5,5	8,5	200	28,75
STM-16 D	17,0	M10	36,0	12,0	48,0	20,0	5,5	8,5	200	29,75
STM-25 D	14,0	M6	38,0	7,5	45,5	20,0	7,0	10,0	175	37,00
STM-25 D	16,0	M8	38,0	10,0	48,0	20,0	7,0	10,0	175	37,00
STM-25 D	17,0	M10	38,0	12,0	50,0	20,0	7,0	10,0	175	38,00
STM-25 D	19,0	M12	38,0	13,0	51,0	20,0	7,0	10,0	150	39,00
STM-35 D	17,0	M8	42,0	10,0	52,0	20,0	8,2	12,5	100	68,25
STM-35 D	19,0	M10	42,0	12,0	54,0	20,0	8,2	12,5	100	69,25
STM-35 D	21,0	M12	42,0	13,0	55,0	20,0	8,2	12,5	100	70,25
STM-50 D	20,0	M8	52,0	10,0	62,0	28,0	10,0	14,5	60	96,40
STM-50 D	22,0	M10	52,0	12,0	64,0	28,0	10,0	14,5	60	96,40
STM-50 D	24,0	M12	52,0	13,0	65,0	28,0	10,0	14,5	60	97,40
STM-70 D	24,0	M8	55,0	10,0	65,0	28,0	11,5	16,5	50	123,85
STM-70 D	24,0	M10	55,0	12,0	67,0	28,0	11,5	16,5	50	123,85
STM-70 D	24,0	M12	55,0	13,0	68,0	28,0	11,5	16,5	50	124,85
STM-95 D	28,0	M10	65,0	12,0	77,0	35,0	13,5	19,0	35	175,60
STM-95 D	28,0	M12	65,0	13,0	78,0	35,0	13,5	19,0	35	175,60
STM-95 D	28,0	M14	65,0	14,5	79,5	35,0	13,5	19,0	35	176,60



BAKIR KABLO PABUCLARI (DIN NORM) COPPER CABLE LUGS (DIN NORM)

Gözde yalıtımsız düz boru kablo pabuçları tip tasarım.
Soket: DIN EN 13600'e göre bakır yüzey kalay kaplı.
Sıcaklık aralığı: +120° C'ye kadar.

Popular non-insulated straight tube cable lugs type design.
Socket: copper according to DIN EN 13600. Surface tin-plated.
Temperature range: up to + 120°C

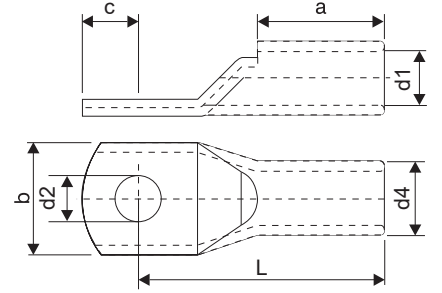

KOD CODE	b	d2	L	c	L+c	a	d1	d4	KUTU ADET BOX PİECES	FİYAT (TÜRK LİRASI)
STM-120 D	32,0	M10	70,0	15,0	85,0	35,0	15,5	21,0	30	223,30
STM-120 D	32,0	M12	70,0	16,0	86,0	35,0	15,5	21,0	30	223,30
STM-120 D	32,0	M14	70,0	18,0	88,0	35,0	15,5	21,0	30	224,30
STM-150 D	34,0	M10	78,0	15,0	93,0	35,0	17,0	23,5	15	318,60
STM-150 D	34,0	M12	78,0	16,0	94,0	35,0	17,0	23,5	15	318,60
STM-150 D	34,0	M14	78,0	19,0	97,0	35,0	17,0	23,5	15	319,60
STM-185 D	37,0	M10	82,0	15,0	97,0	40,0	19,0	25,5	12	358,00
STM-185 D	37,0	M12	82,0	16,0	98,0	40,0	19,0	25,5	12	358,00
STM-185 D	37,0	M14	82,0	19,0	101,0	40,0	19,0	25,5	12	358,00
STM-185 D	37,0	M16	82,0	19,0	101,0	40,0	19,0	25,5	12	358,00
STM-240 D	42,0	M12	92,0	16,0	108,0	40,0	21,5	29,0	8	508,75
STM-240 D	42,0	M14	92,0	19,0	111,0	40,0	21,5	29,0	8	508,75
STM-240 D	42,0	M16	92,0	19,0	111,0	40,0	21,5	29,0	8	508,75
STM-300 D	48,0	M16	100,0	19,0	119,0	50,0	24,5	32,0	8	591,25
STM-300 D	48,0	M20	100,0	22,0	122,0	50,0	24,5	32,0	8	591,25
STM-400 D	55,0	M16	115,0	25,0	140,0	70,0	27,5	38,5	5	1.185,00
STM-400 D	55,0	M20	115,0	25,0	140,0	70,0	27,5	38,5	5	1.185,00



ALÜMİNYUM KABLO PABUCU ALUMINUM CABLE LUGS

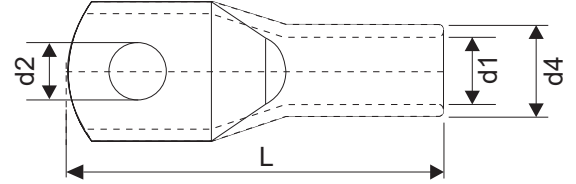

- Ürün üzeri 3 kaplamadan yapılmıştır. • On the product It consists of 3 coatings.

- * Temizleme
- * Bakır Kaplama
- * Elektron Kumlama

- * Clearing
- * Copper Plated
- * Electron Sandblasting

KOD CODE	KESİT SECTION	d2	AÇIKLAMA EXPLANATION	L	d1	d4	ÜRÜN AĞIRLIĞI PRODUCT WEIGHT	KUTU AĞIRLIĞI BOX WEIGHT	KUTU ADET BOX PIECES	FİYAT (TÜRK LİRASI)
STM ALS-16	16mm	M8	Kablo pabucu (Alm.)	57,5	6,0	10	7,15g	~3,0kg	400	11,70
STM ALS-25	25mm	M8	Kablo Pabucu (Alm.)	63,5	7,0	12	11,60g	~3,6kg	300	15,30
STM ALS-35	35mm	M8	Kablo pabucu (Alm.)	74,0	8,0	14	17,50g	~2,7kg	150	25,50
STM ALS-50	50mm	M10	Kablo Pabucu (Alm.)	82,0	10,0	16	24,80g	~3,2kg	125	31,50
STM ALS-70	70mm	M12	Kablo pabucu (Alm.)	95,0	12,0	18	35,00g	~3,6kg	100	43,85
STM ALS-95	95mm	M12	Kablo Pabucu (Alm.)	100,0	13,7	21	47,62g	~3,7kg	75	60,20
STM ALS-120	120mm	M12	Kablo pabucu (Alm.)	111,0	14,0	22	65,20g	~3,4kg	50	73,20
STM ALS-150	150mm	M12	Kablo Pabucu (Alm.)	112,5	16,0	24	68,80g	~2,9kg	40	76,30
STM ALS-185	185mm	M12	Kablo pabucu (Alm.)	126,5	17,7	26	96,20g	~3,0kg	30	102,20
STM ALS-240	240mm	M12	Kablo Pabucu (Alm.)	142,0	21,0	30	120,80g	~3,1kg	25	119,50



EURO MODEL

ALÜMİNYUM BAKIR KABLO PABUCU - BI METAL

ALUMINUM COPPER CABLE LUGS - BI METAL

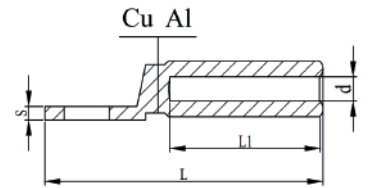
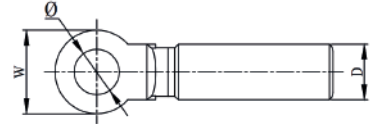

KOD CODE	Ø	D	d	L	L1	W	S	ÜRÜN AĞIRLIĞI PRODUCT WEIGHT	KUTU AĞIRLIĞI BOX WEIGHT	KUTU ADET BOX PIECES	FİYAT (BİRLİK)
STM BI-16	11	16	6	80	40	20	3	37,60g	~0,7kg	20	3,00 \$
STM BI-25	11	16	7	80	40	20	3	36,80g	~0,7kg	20	3,00 \$
STM BI-35	11	16	8,5	80	40	20	3	34,50g	~0,6kg	20	3,00 \$
STM BI-50	13	20	10	90	44	24	4	62,00g	~0,6kg	10	3,90 \$
STM BI-70	13	20	11,5	90	44	24	4	59,00g	~0,5kg	10	3,90 \$
STM BI-95	13	20	13,5	90	44	24	4	53,30g	~0,5kg	10	3,90 \$
STM BI-120	13	25	15	115	60	30	4,5	112,00g	~0,5kg	5	6,90 \$
STM BI-150	13	25	16,5	115	60	30	4,5	107,30g	~0,5kg	5	6,90 \$
STM BI-185	13	32	18,5	122	60	35	6	207,00g	~0,5kg	5	12,00 \$
STM BI-240	13	32	21	122	60	35	6	193,20g	~1,0kg	5	12,00 \$
STM BI-300	13	34	23,5	128	65	35	6	205,30g	~0,9kg	5	13,75 \$
STM BI-400	13	40	26	160	95	36	6	337,00g	~1,6kg	5	22,50 \$



BAKIR SIKMALI EK MUFLAR (EKO MODEL) COPPER CLAMP ADDITIONAL MUFS (ECO MODEL)

- Ürün üzeri 3 kaplamadan yapılmıştır. • On the product It consists of 3 coatings.
- * Temizleme * Clearing
- * Bakır Kaplama * Copper Plated
- * Elektron Kumlama * Electron Sandblasting

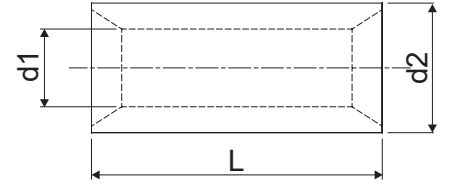

KOD CODE	KESİT CROSS SECTION	AÇIKLAMA EXPLANATION	L	d1	d2	ÜRÜN AĞIRLIĞI PRODUCT WEIGHT	KUTU AĞIRLIĞI BOX WEIGHT	KUTU ADET BOX PİECES	FİYAT (TÜRK LİRASI)
STM SEM-10	10mm	Sıkmalı Ek Muf (Bakır)	28	5,0	6,5	3,30g	~2,7kg	800	12,25
STM SEM-16	16mm	Sıkmalı Ek Muf (Bakır)	30	5,6	6,9	3,50g	~1,8kg	500	12,25
STM SEM-25	25mm	Sıkmalı Ek Muf (Bakır)	39	7,0	8,8	7,70g	~2,4kg	300	18,75
STM SEM-35	35mm	Sıkmalı Ek Muf (Bakır)	44	8,2	10,0	10,40g	~2,1kg	200	29,20
STM SEM-50	50mm	Sıkmalı Ek Muf (Bakır)	50	10,2	11,8	12,85g	~2,0kg	150	34,40
STM SEM-70	70mm	Sıkmalı Ek Muf (Bakır)	55	11,7	13,9	22,20g	~2,3kg	100	54,20
STM SEM-95	95mm	Sıkmalı Ek Muf (Bakır)	59	13,6	15,6	24,60g	~1,9kg	75	68,40
STM SEM-120	120mm	Sıkmalı Ek Muf (Bakır)	69	15,5	17,7	35,75g	~1,8kg	50	81,10
STM SEM-150	150mm	Sıkmalı Ek Muf (Bakır)	76	16,7	19,7	57,70g	~2,4kg	40	123,65
STM SEM-185	185mm	Sıkmalı Ek Muf (Bakır)	84	18,8	21,9	73,71g	~2,3kg	30	151,20
STM SEM-240	240mm	Sıkmalı Ek Muf (Bakır)	88	21,2	25,0	112,30g	~2,9kg	25	224,85



ALÜMİNYUM SIKMALI EK MUFLAR ALUMINUM CLAMP ADDITIONAL MUFS

- Ürün üzeri 3 kaplamadan yapılmıştır. • On the product It consists of 3 coatings.
- * Temizleme * Clearing
- * Bakır Kaplama * Copper Plated
- * Elektron Kumlama * Electron Sandblasting



KOD CODE	KESİT CROSS SECTION	AÇIKLAMA EXPLANATION	L	d1	d2	ÜRÜN AĞIRLIĞI PRODUCT WEIGHT	KUTU AĞIRLIĞI BOX WEIGHT	KUTU ADET BOX PIECES	FİYAT (TÜRK LİRASI)
STM ALM-16	16mm	Sıkmalı Ek Muf (Alüminyum)	58	10	6,0	7,85g	~3,3kg	400	11,70
STM ALM-25	25mm	Sıkmalı Ek Muf (Alüminyum)	66	12	7,0	13,25g	~3,4kg	250	15,30
STM ALM-35	35mm	Sıkmalı Ek Muf (Alüminyum)	75	14	8,0	18,80g	~2,9kg	150	25,50
STM ALM-50	50mm	Sıkmalı Ek Muf (Alüminyum)	83	16	10,0	27,20g	~3,5kg	125	31,50
STM ALM-70	70mm	Sıkmalı Ek Muf (Alüminyum)	97	18	12,0	39,00g	~4,0kg	100	43,85
STM ALM-95	95mm	Sıkmalı Ek Muf (Alüminyum)	106	21	13,7	53,10g	~4,1kg	75	60,20
STM ALM-120	120mm	Sıkmalı Ek Muf (Alüminyum)	114	22	14,0	71,50g	~3,7kg	50	73,20
STM ALM-150	150mm	Sıkmalı Ek Muf (Alüminyum)	116	24	16,0	75,00g	~3,1kg	40	76,30
STM ALM-185	185mm	Sıkmalı Ek Muf (Alüminyum)	128	26	17,7	106,60g	~3,3kg	30	102,20
STM ALM-240	240mm	Sıkmalı Ek Muf (Alüminyum)	145	30	21,0	128,20g	~3,3kg	25	119,50

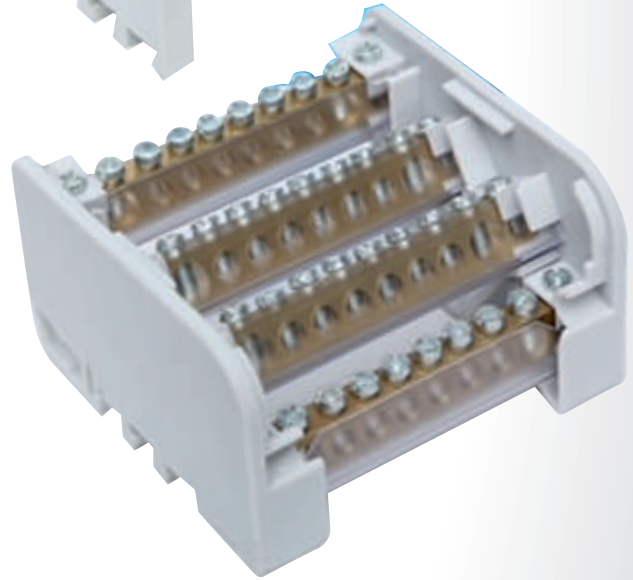
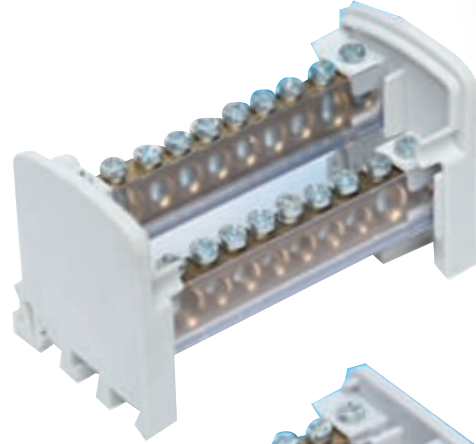

DAĞITIM ÜNİTESİ DISTRIBUTION UNIT

KOD CODE	AÇIKLAMA EXPLANATION	AMPER	KUTUP	KUTU ADET BOX PIECES	FİYAT (TÜRK LİRASI)
STM 207	2x7 Dağıtım Ünitesi	125A	2	1	240,00
STM 211	2x11 Dağıtım Ünitesi	125A	2	1	350,00
STM 215	2x15 Dağıtım Ünitesi	125A	2	1	440,00
STM 407	4x7 Dağıtım Ünitesi	125A	4	1	440,00
STM 411	4x11 Dağıtım Ünitesi	125A	4	1	640,00
STM 415	4x15 Dağıtım Ünitesi	125A	4	1	780,00

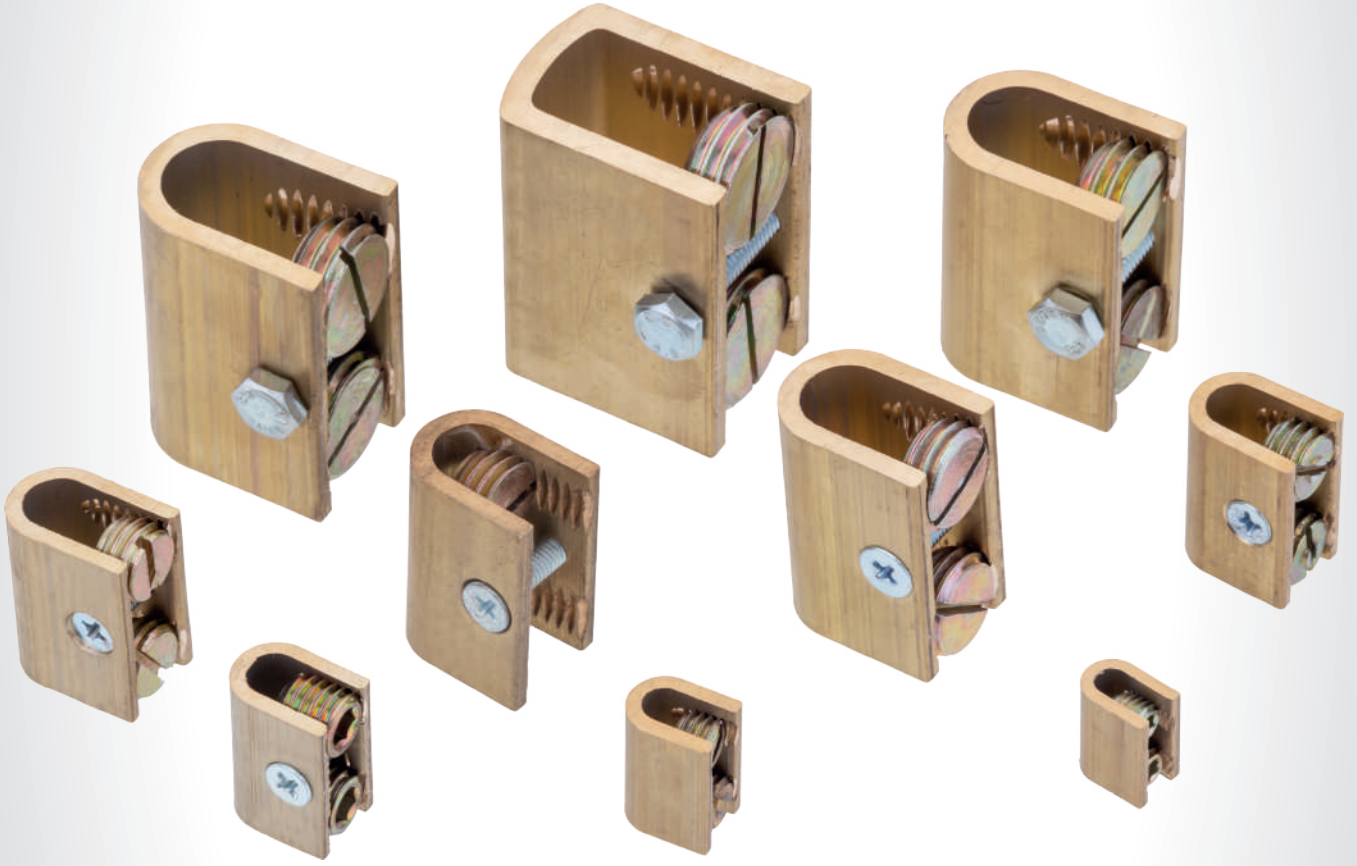

U KLEMENSLER (PRİNÇ)

U TERMINALS

KOD CODE	KESİT CROSS SECTION	AÇIKLAMA EXPLANATION	KUTU ADET BOX PIECES	FİYAT (TÜRK LİRASI)
STM U-6	6mm ²	U Klemens (Prinç)	350	24,90
STM U-10	10mm ²	U Klemens (Prinç)	200	33,50
STM U-16	16mm ²	U Klemens (Prinç)	125	44,00
STM U-25	25mm ²	U Klemens (Prinç)	100	52,00
STM U-35	35mm ²	U Klemens (Prinç)	75	54,40
STM U-50	50mm ²	U Klemens (Prinç)	50	83,50
STM U-70	70mm ²	U Klemens (Prinç)	40	102,50
STM U-95	95mm ²	U Klemens (Prinç)	25	141,60
STM U-120	120mm ²	U Klemens (Prinç)	20	163,50
STM U-150	150mm ²	U Klemens (Prinç)	15	251,30

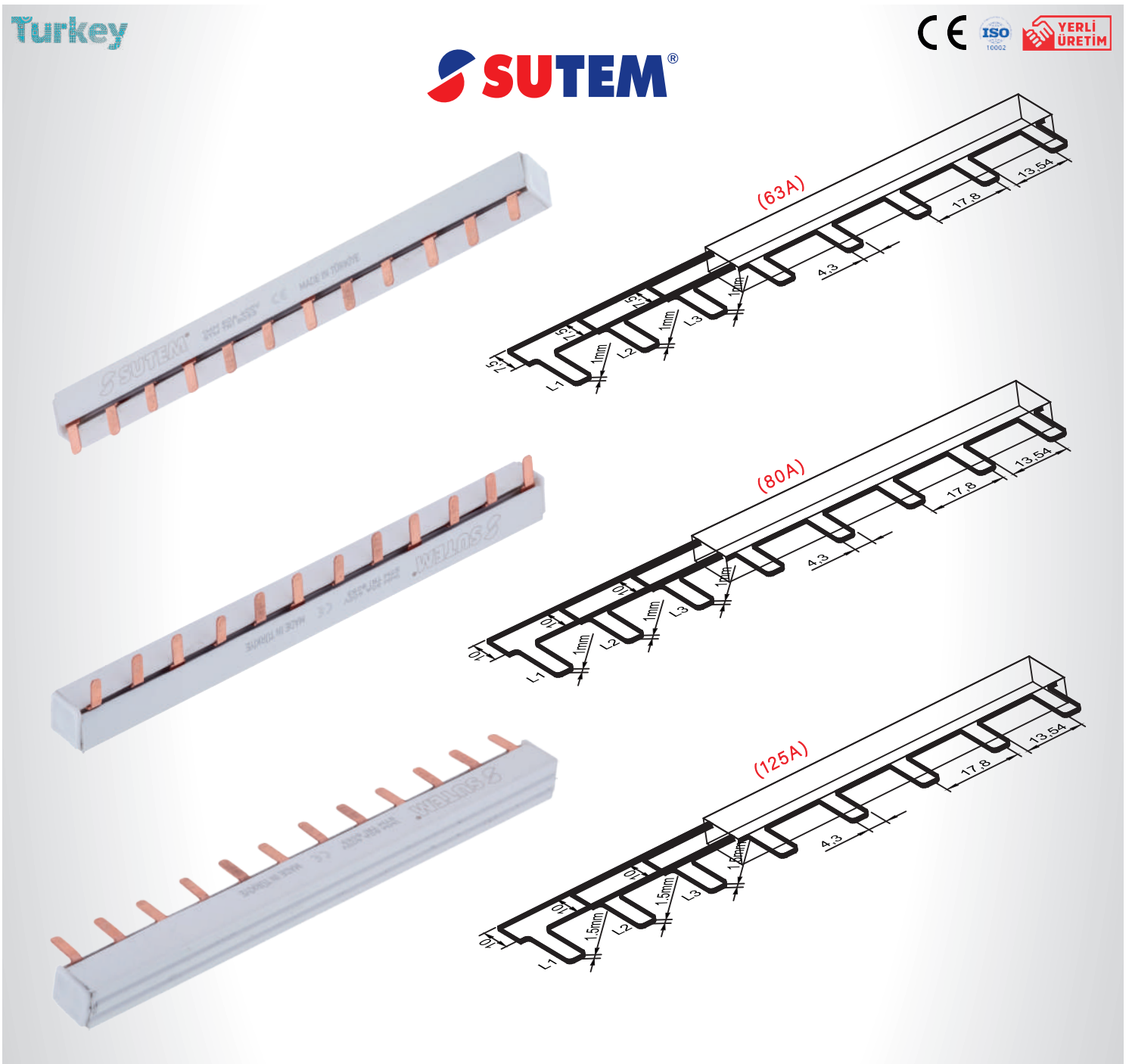

TRİFAZE W OTOMAT BARASI THREE-PHASE W VENDING BUSBAR

Özel ölçüler için iletişime geçebilirsiniz.
You can contact for special sizes.

KOD CODE	AÇIKLAMA EXPLANATION	AMPER	MODÜL	KUTU ADET BOX PIECES	FİYAT (TÜRK LİRASI)
STM TRİ-6353	1 mm Elektrolitik Bakır 53 cm	63A	10	25	380,00
STM TRİ-63106	1 mm Elektrolitik Bakır 106 cm	63A	20	25	760,00
STM TRİ-8053	1 mm Elektrolitik Bakır 53 cm	80A	10	25	440,00
STM TRİ-80106	1 mm Elektrolitik Bakır 106 cm	80A	20	25	880,00
STM TRİ-12553	1,5 mm Elektrolitik Bakır 53 cm	125A	10	25	675,00
STM TRİ-125106	1,5 mm Elektrolitik Bakır 106 cm	125A	20	25	1.350,00
STM TRİ-KPK	Trifaze Bara Yan Kapağı	-	-	1000	5,75

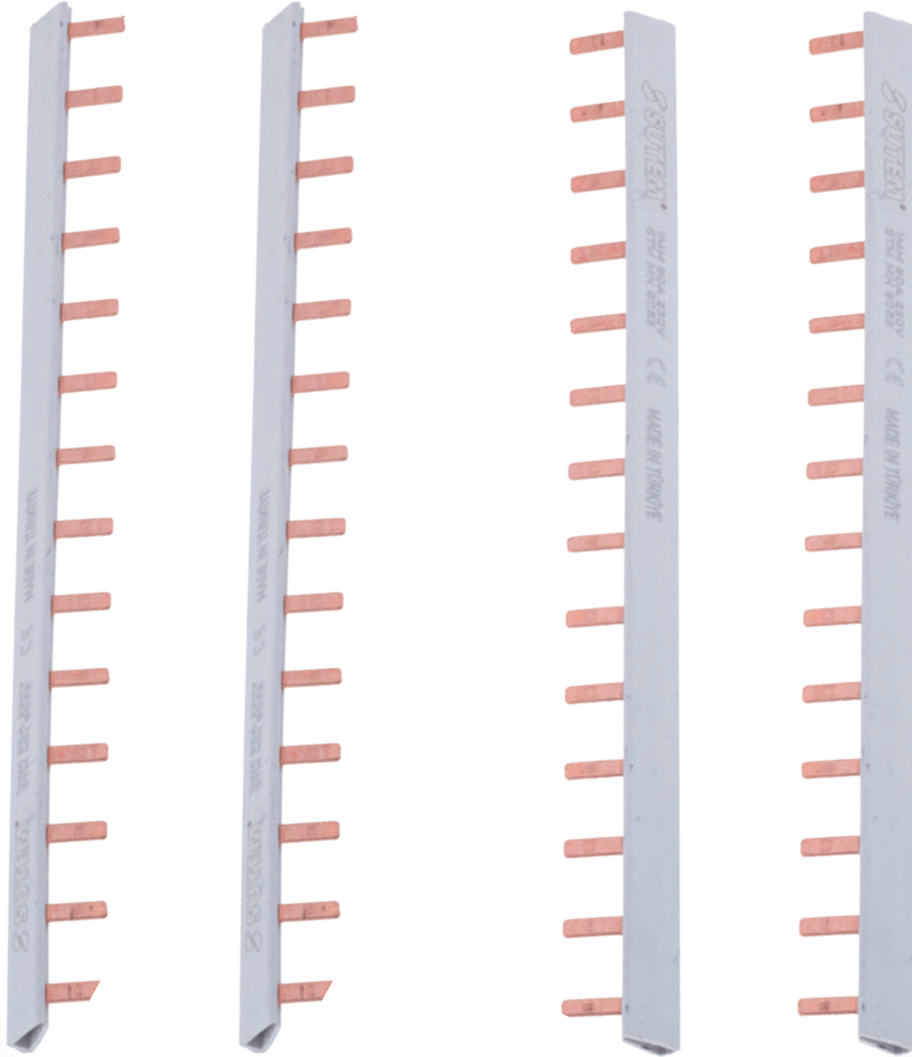

MONOFAZE W OTOMAT BARASI MONOPHASE W VENDING BUSBAR

Özel ölçüler için iletişime geçebilirsiniz.
You can contact for special sizes.

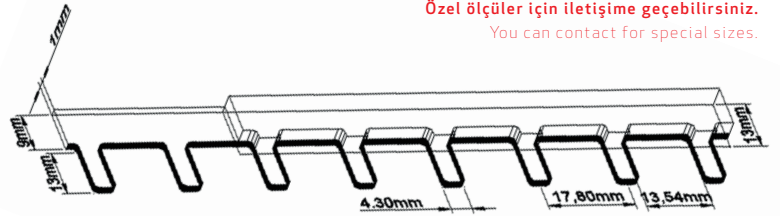

KOD CODE	AÇIKLAMA EXPLANATION	AMPER	MODÜL	KUTU ADET BOX PIECES	FİYAT (TÜRK LİRASI)
STM MN-8053	1 mm Elektrolitik Bakır 53 cm	80A	30	50	180,00
STM MN-80106	1 mm Elektrolitik Bakır 106 cm	80A	60	50	360,00
STM MN-12553	1,5 mm Elektrolitik Bakır 53 cm	125A	30	50	(Fiyat Sorunuz.)
STM MN-125106	1,5 mm Elektrolitik Bakır 106 cm	125A	60	50	(Fiyat Sorunuz.)

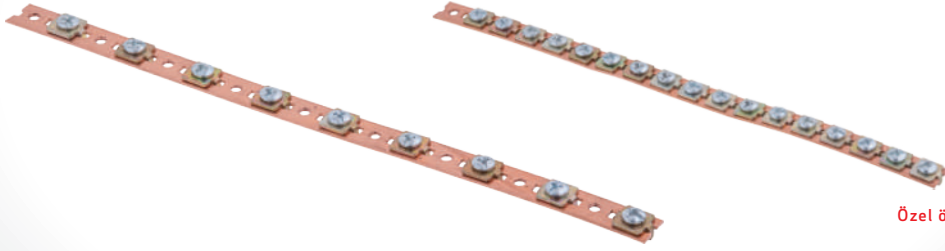

Özel ölçüler için iletişime geçebilirsiniz.
You can contact for special sizes.

NÖTR TOPRAKLAMA BARASI NEUTRAL GROUNDING BUSBAR

KOD CODE	AÇIKLAMA EXPLANATION	KUTU ADET BOX PİECES	FİYAT (TÜRK LİRASI)
STM NTR-1531	15 x1,5 mm x1 metre 31 vida	40	520,00
STM NTR-1561	15 x1,5 mm x1 metre 61 vida	40	635,00
STM NTR-0231	15 x2 mm x1 metre 31 vida	40	610,00
STM NTR-0261	15 x2 mm x1 metre 61 vida	40	700,00
STM NTR-0331	15 x3 mm x1 metre 31 vida	40	855,00
STM NTR-0361	15 x3 mm x1 metre 61 vida	40	947,00



KOMPAKT UZATMA BARASI COMPACT EXTENSION BAR

Kompakt Uzatma Barası (3mm)

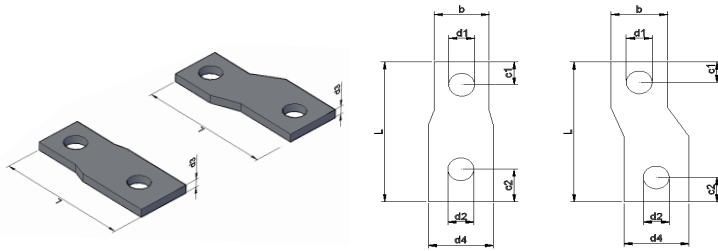

Kompakt Uzatma Barası (5mm)

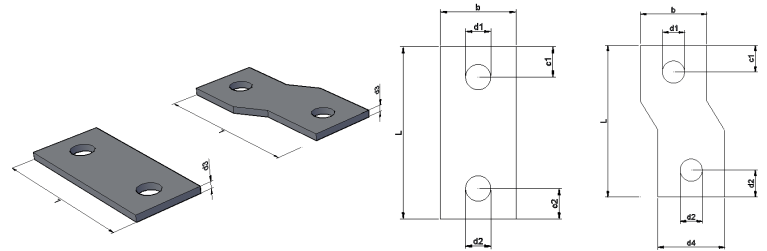

KOD CODE	AÇIKLAMA EXPLANATION	d3	b	d2	L	c1	c2	d1	d4	KUTUP	MODÜL	KUTU ADET BOX PİECES	FİYAT (TÜRK LİRASI)
STM-250-U	Kompakt Uzatma Barası	3mm	17	M8	49	8	15	M8	20	3	1	1 Takım	970,00
STM-400-U	Kompakt Uzatma Barası	5mm	30	M10	68	12	14	M10	30	3	1	1 Takım	2.045,00

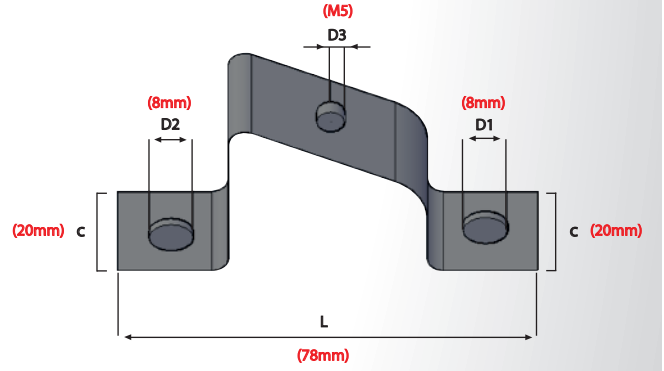
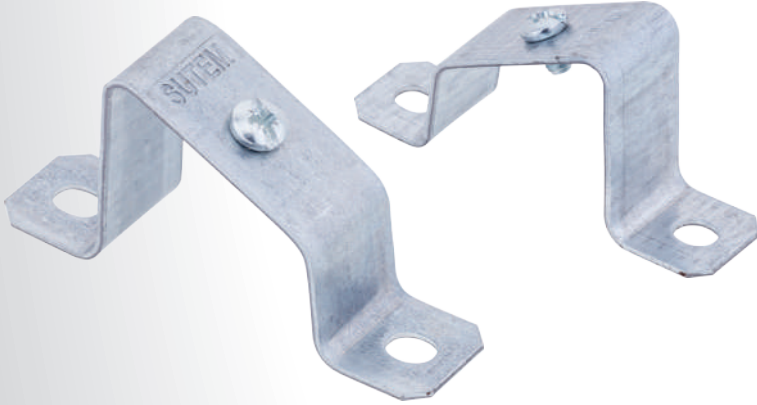
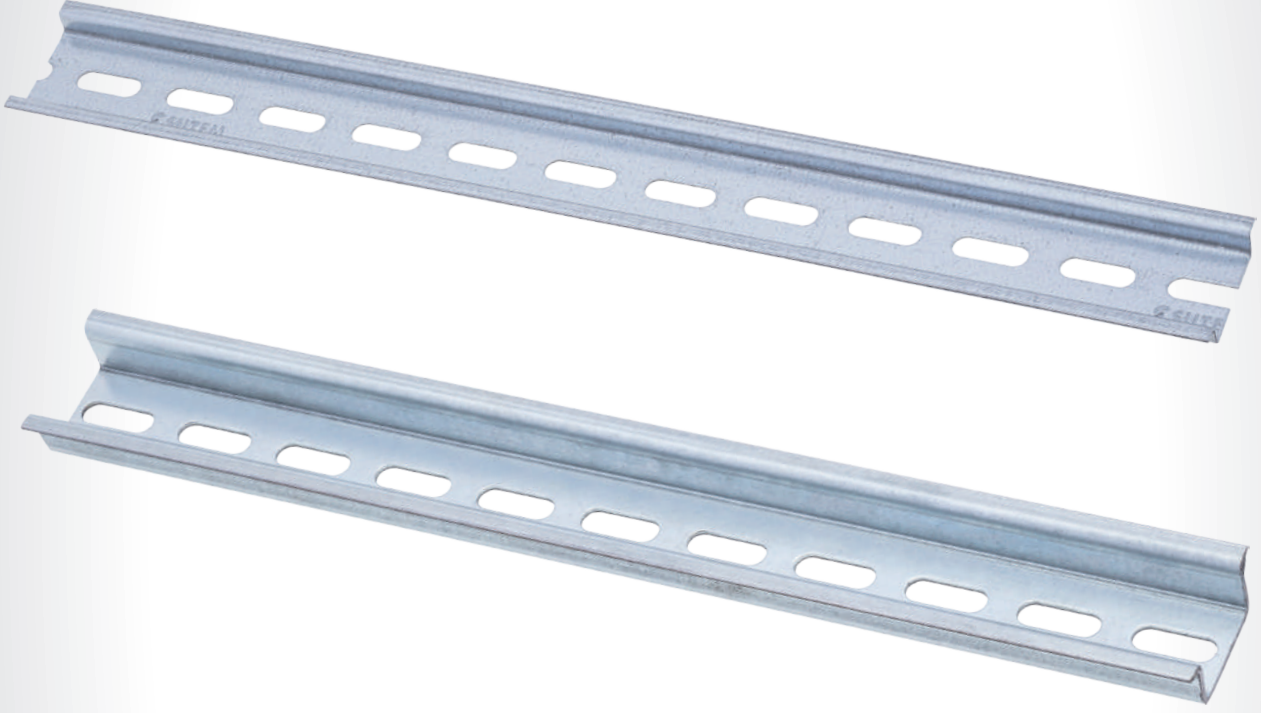

W OTOMAT RAYI DIN RAIL

Özel ölçüler için iletişime geçebilirsiniz.
You can contact for special sizes.

KOD CODE	AÇIKLAMA EXPLANATION	TABAN	UZUNLUK	KUTU ADET BOX PİECES	FİYAT (TÜRK LİRASI)
STM-RAY-DL-030	Delikli Sac Ray	35x7,5	30 cm	100	15,00
STM-RAY-DL-1M	Delikli Sac Ray	35x7,5	1m	50	50,00
STM-RAY-DL-2M	Delikli Sac Ray	35x7,5	2m	25	100,00
STM-RAY-DZ-030	Düz Sac Ray	35x7,5	30 cm	100	15,00
STM-RAY-DZ-1M	Düz Sac Ray	35x7,5	1 m	50	50,00
STM-RAY-DZ-2M	Düz Sac Ray	35x7,5	2m	25	100,00
STM DRN-1M	Delikli Sac Ray	35x15	1 m	25	120,00
STM DRN-2M	Delikli Sac Ray	35x15	2m	25	240,00
STM 02-12	Sac Ray Taşıyıcı	-	-	100	18,50



PANO TOPRAKLAMA KLEMENS (AYAKSIZ) 6,5 x 9mm 80A
PANEL GROUNDING TERMINAL (WITHOUT FEET) 6,5 x 9mm 80A

KOD CODE	AÇIKLAMA EXPLANATION	KUTU ADET BOX PIECES	FİYAT (TÜRK LİRASI)
STM5000	2+4 Delikli Pano Topraklama Klemens	300	39,00
STM5001	2+5 Delikli Pano Topraklama Klemens	300	43,00
STM5004	2+8 Delikli Pano Topraklama Klemens	300	54,00
STM5005	2+10 Delikli Pano Topraklama Klemens	300	60,00
STM5006	2+13 Delikli Pano Topraklama Klemens	300	76,00
STM5007	2+18 Delikli Pano Topraklama Klemens	300	102,00
STM5008	2+23 Delikli Pano Topraklama Klemens	300	127,00
STM5009	2+28 Delikli Pano Topraklama Klemens	300	155,00

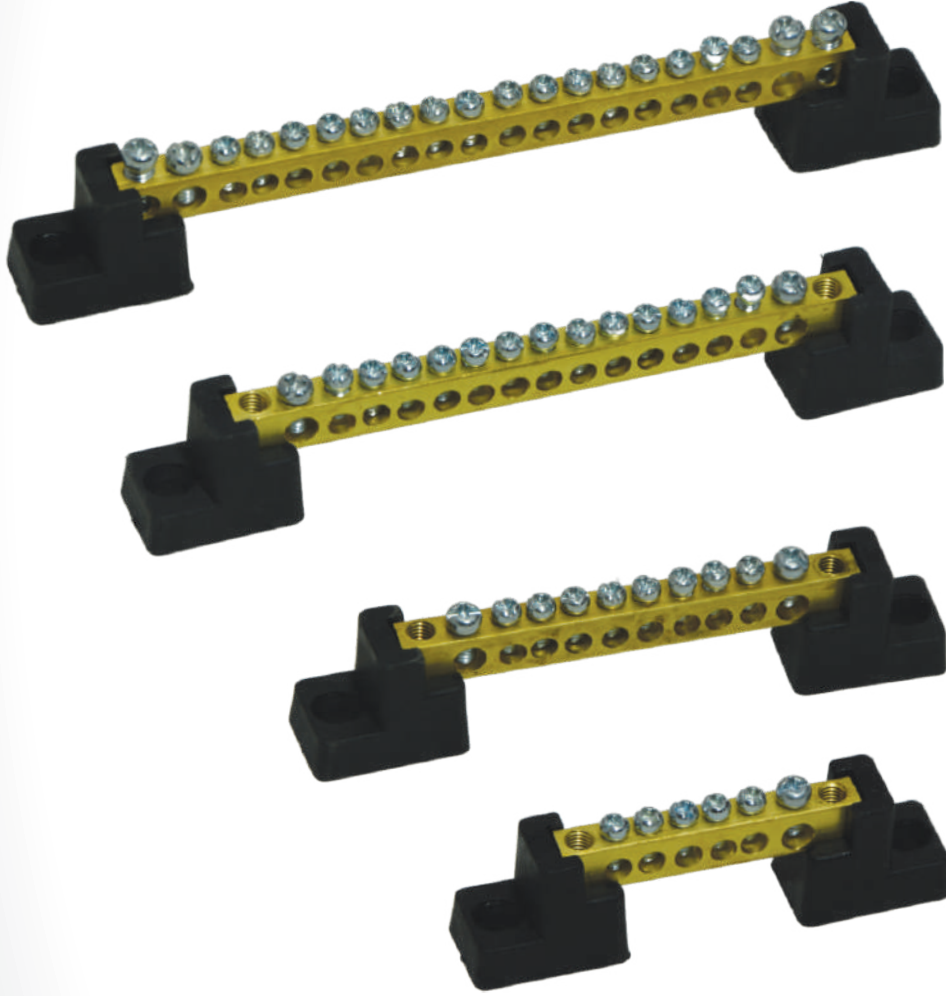

PANO TOPRAKLAMA KLEMENS (AYAKLI) 6,5 x 9mm 80A

PANEL GROUNDING TERMINAL (WITH FEET) 6,5x 9mm 80A

KOD CODE	AÇIKLAMA EXPLANATION	KUTU ADET BOX PIECES	FİYAT (TÜRK LİRASI)
STM5010	2+4 Delikli Pano Topraklama Klemens	150	48,00
STM5011	2+5 Delikli Pano Topraklama Klemens	150	52,00
STM5014	2+8 Delikli Pano Topraklama Klemens	150	68,00
STM5015	2+10 Delikli Pano Topraklama Klemens	150	76,00
STM5016	2+13 Delikli Pano Topraklama Klemens	150	88,00
STM5017	2+18 Delikli Pano Topraklama Klemens	150	112,00
STM5018	2+23 Delikli Pano Topraklama Klemens	150	132,00
STM5019	2+28 Delikli Pano Topraklama Klemens	150	186,00

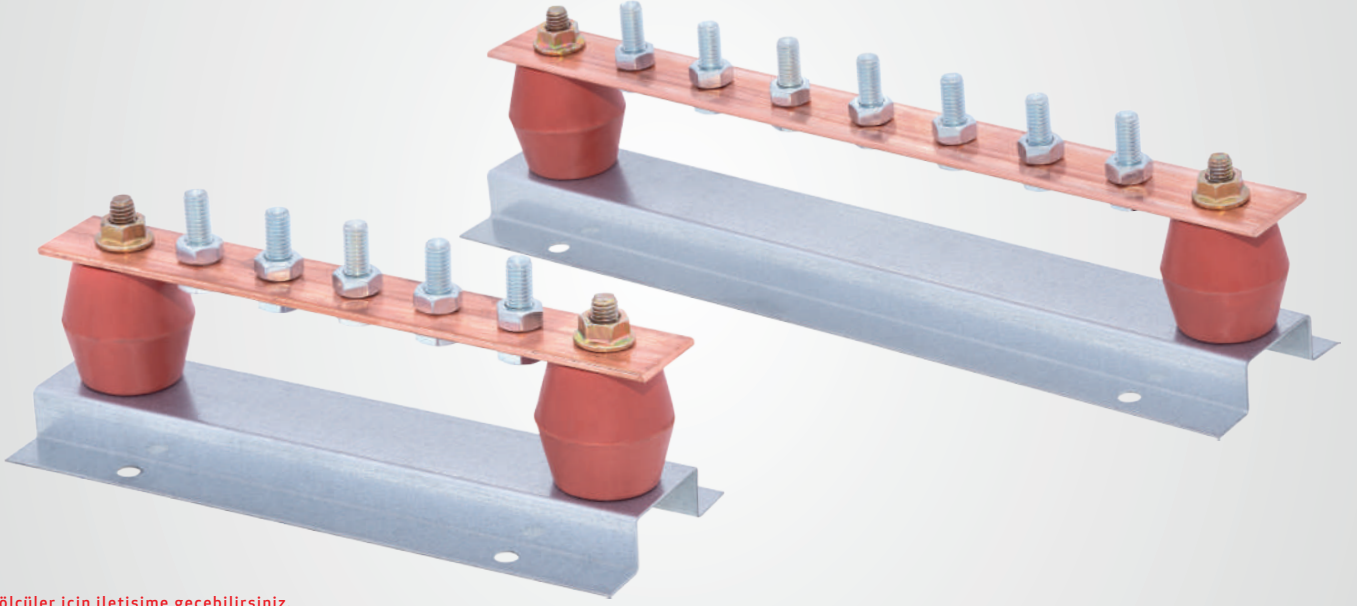

Özel ölçüler için iletişime geçebilirsiniz.
You can contact for special sizes.

TOPRAKLAMA EŞ POTANSİYEL BARASI BAR HOLDER SERFİL

KOD CODE	(20x3)	AÇIKLAMA EXPLANATION	KUTU ADET BOX PIECES	FİYAT (TÜRK LİRASI)
STM 1049		20 cm (M6-5 Civata)	200A	1 350,00
STM 1050		25 cm (M6-6 Civata)	200A	1 410,00
STM 1051		30 cm (M6-7 Civata)	200A	1 475,00

KOD CODE	(30x3)	AÇIKLAMA EXPLANATION	KUTU ADET BOX PIECES	FİYAT (TÜRK LİRASI)
STM 1053		20 cm (M8-5 Civata)	300A	1 435,00
STM 1054		25 cm (M8-6 Civata)	300A	1 650,00
STM 1055		30 cm (M8-7 Civata)	300A	1 750,00

KOD CODE	(30x5)	AÇIKLAMA EXPLANATION	KUTU ADET BOX PIECES	FİYAT (TÜRK LİRASI)
STM 1057		20 cm (M8-5 Civata)	400A	1 750,00
STM 1058		25 cm (M8-6 Civata)	400A	1 885,00
STM 1059		30 cm (M8-7 Civata)	400A	1 1.020,00



AL-CU KLEMENSLER (EKO)

AL-CU TERMINALS (ECONOMIC)

KOD CODE	AÇIKLAMA EXPLANATION	KUTU ADET BOX PİECES	FİYAT (TÜRK LİRASI)
STM 1060	A25-B16 AL-CU Klemens	100	43,50
STM 1061	A40-B25 AL-CU Klemens	100	55,00
STM 1062	A70-B50 AL-CU Klemens	50	79,00
STM 1063	A120-B70 AL-CU Klemens	50	165,00
STM 1064	A240-B120 AL-CU Klemens	25	400,00



BRANŞMAN KLEMENSLER (EKO)

BRANCH TERMINALS (ECONOMIC)

KOD CODE	AÇIKLAMA EXPLANATION	KUTU ADET BOX PİECES	FİYAT (TÜRK LİRASI)
STM 1070	A25-A25 Branşman Klemens	100	36,40
STM 1071	A40-A40 Branşman Klemens	100	39,50
STM 1072	A70-A70 Branşman Klemens	50	64,90
STM 1073	A120-A120 Branşman Klemens	50	116,50
STM 1074	A240-A240 Branşman Klemens	25	344,00



TIRNAKLI KLEMENSLER

NAILED TERMINALS

KOD CODE	AÇIKLAMA EXPLANATION	KUTU ADET BOX PİECES	FİYAT (TÜRK LİRASI)
STM TRN-2	No:2 25mm Tırnaklı Klemens	100	(Fiyat Sorunuz.)
STM TRN-3	No:3 35mm Tırnaklı Klemens	100	(Fiyat Sorunuz.)
STM TRN-4	No:4 50mm Tırnaklı Klemens	50	(Fiyat Sorunuz.)
STM TRN-5	No:5 70mm Tırnaklı Klemens	50	(Fiyat Sorunuz.)
STM TRN-67	No:6 6-7 95-120mm Tırnaklı Kl.m.	25	(Fiyat Sorunuz.)



MİNİK FIÇI BOY İZOLATÖR TINY BARREL SIZE INSULATOR

KOD CODE	AÇIKLAMA EXPLANATION	KUTU ADET BOX PIECES	FİYAT (TÜRK LİRASI)
STM M5-2C	İki Tarafı Civatalı	200	19,25
STM M5-2S	İki Tarafı Somonlu	200	29,00
STM M5-1C + 1S	Tek Taraf Somun Tek taraf Civata	200	28,00



ORTA BOY KONİK İZOLATÖR MEDIUM SIZE CONICAL INSULATOR

KOD CODE	AÇIKLAMA EXPLANATION	KUTU ADET BOX PIECES	FİYAT (TÜRK LİRASI)
STM M6-2C	İki Tarafı Civatalı	100	26,85
STM M6-2S	İki Tarafı Somonlu	100	33,80
STM M6-1C + 1S	Tek Taraf Somun Tek taraf Civata	100	29,20

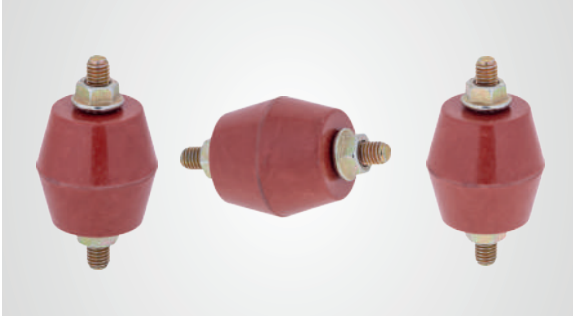

BÜYÜK BOY FIÇI İZOLATÖR MEDIUM SIZE CONICAL INSULATOR

KOD CODE	AÇIKLAMA EXPLANATION	KUTU ADET BOX PIECES	FİYAT (TÜRK LİRASI)
STM M8-2C	İki Tarafı Civatalı	50	44,30
STM M8-2S	İki Tarafı Somonlu	50	51,50
STM M8-1C + 1S	Tek Taraf Somun Tek taraf Civata	50	47,85

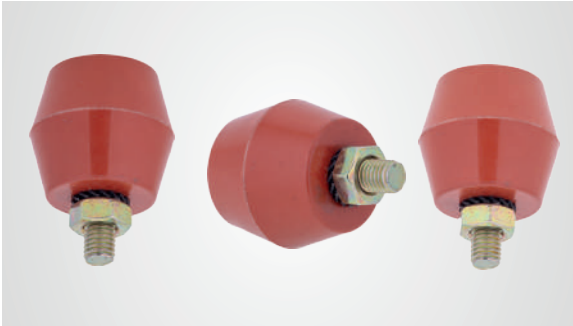

BÜYÜK BOY FIÇI İZOLATÖR MEDIUM SIZE CONICAL INSULATOR

KOD CODE	AÇIKLAMA EXPLANATION	KUTU ADET BOX PIECES	FİYAT (TÜRK LİRASI)
STM M10-2C	İki Tarafı Civatalı	50	63,00
STM M10-2S	İki Tarafı Somonlu	50	70,00
STM M10-1C + 1S	Tek Taraf Somun Tek taraf Civata	50	66,50

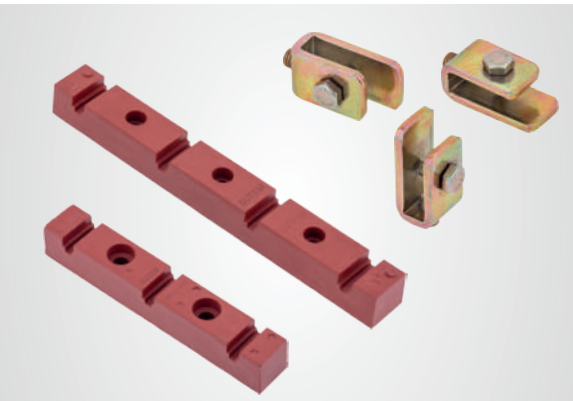

TARAK İZOLATÖR - BARA TUTUCU SERFİL MEDIUM SIZE CONICAL INSULATOR - BAR HOLDER SERFIL

KOD CODE	AÇIKLAMA EXPLANATION	KUTU ADET BOX PIECES	FİYAT (TÜRK LİRASI)
STM 31F	3x1F Tarak İzolatör	60	64,20
STM 32F	3x2F Tarak İzolatör	48	85,20
STM 31FN	3x1F+N Tarak İzolatör	30	87,50
STM 32FN	3x2F+N Tarak İzolatör	30	115,00
STM 01-17	M8-M10 Serfil	50	50,20



STANDART KABLO BAĞLARI STANDARD CABLE TIES

KOD CODE	BOYUTLAR / DİMENSIYONLAR		RENK COLOR	BAĞLAMA ÇAP TİE DİAMETER	MUKAVEMETİ STRENGTH	ADET PIECES	FİYAT (TÜRK LİRASI)
	EN	BOY					
STM-02510	2,5	100	Siyah-Beyaz	18 mm	8.1 kg	1000	0,245
STM-02515		150		35mm		1000	0,415
STM-02520		200		50mm		1000	0,585
STM-03615	3,6	150	Siyah-Beyaz	35mm	18.0 kg	100	0,695
STM-03620		200		50mm		100	0,902
STM-03625		250		65mm		100	1,115
STM-03630		300		76mm		100	1,456
STM-03637		370		102mm		100	1,786
STM-04820	4,8	200	Siyah-Beyaz	50mm	22.0 kg	100	1,071
STM-04825		250		60mm		100	1,422
STM-04830		300		76mm		100	1,766
STM-04838		380		105mm		100	2,354
STM-04840		400		115mm		100	2,512
STM-07630	7,6	300	Siyah-Beyaz	76mm	55.0 kg	100	3,571
STM-07638		380		95mm		100	4,611
STM-07645		450		115mm		100	5,182
STM-07655		550		140mm		100	6,532
STM-09075	9,0	750	Siyah-Beyaz	200mm	80.0 kg	100	11,60
STM-09095		950		263mm		100	15,31



KABLO TOPLAMA ÇORABI POLYCARBONATE BOARDS

KOD CODE	AÇIKLAMA EXPLANATION	KUTU ADET BOX PIECES	FİYAT (DOLAR)
STM ÇRP3	3mm Kablo Toplama Çorabı / Siyah	1	0,45 \$
STM ÇRP6	6mm Kablo Toplama Çorabı / Siyah	1	0,54 \$
STM ÇRP8	8mm Kablo Toplama Çorabı / Siyah	1	0,55 \$
STM ÇRP10	10mm Kablo Toplama Çorabı / Siyah	1	0,66 \$
STM ÇRP12	12mm Kablo Toplama Çorabı / Siyah	1	0,80 \$
STM ÇRP15	15mm Kablo Toplama Çorabı / Siyah	1	0,88 \$
STM ÇRP20	20mm Kablo Toplama Çorabı / Siyah	1	1,10 \$
STM ÇRP25	25mm Kablo Toplama Çorabı / Siyah	1	1,35 \$
STM ÇRP30	30mm Kablo Toplama Çorabı / Siyah	1	1,60 \$
STM ÇRP40	40mm Kablo Toplama Çorabı / Siyah	1	2,10 \$
STM ÇRP50	50mm Kablo Toplama Çorabı / Siyah	1	2,60 \$



KABLO TOPLAMA SİRALI CABLE COLLECTION SPIRAL

KOD CODE	AÇIKLAMA EXPLANATION	KUTU ADET BOX PIECES	FİYAT (TÜRK LİRASI)
STM KTS.3020	Ø 20 Kablo Toplama Spirali Gri	25	55,45
STM KTS.3025	Ø 25 Kablo Toplama Spirali Gri	20	67,15
STM KTS.3030	Ø 30 Kablo Toplama Spirali Gri	15	80,85

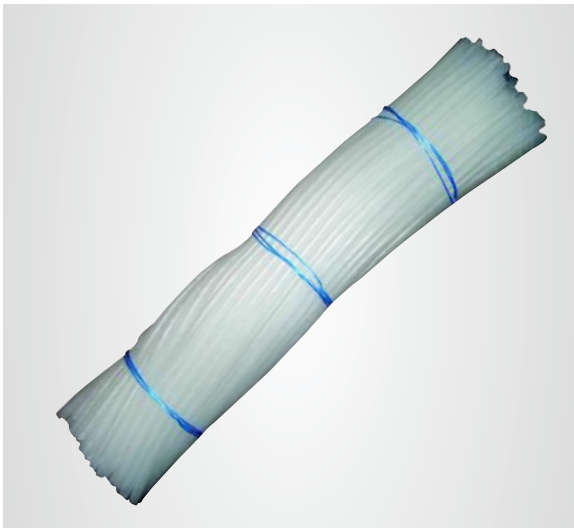

HELEZON PANO SİRALI HELEZON BOARD SPIRAL

KOD CODE	AÇIKLAMA EXPLANATION	KUTU ADET BOX PIECES	FİYAT (TÜRK LİRASI)
STM PS.1738	No.1 (6mm) Helezon Pano Spirali	100	4,22
STM PS.1739	No.2 (8mm) Helezon Pano Spirali	100	5,96
STM PS.1741	No.3 (11mm) Helezon Pano Spirali	100	7,05
STM PS.1742	No.4 (14mm) Helezon Pano Spirali	50	10,16
STM PS.1743	No.5 (17mm) Helezon Pano Spirali	50	12,36







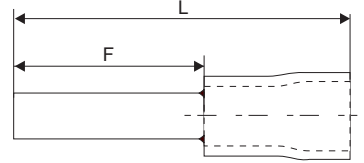





















STANDART TEK GİRİŞLİ İZOLELİ YÜKSÜKLERİ (BAKIR)

STANDARD SINGLE ENTRY INSULATED CABLE THREADS (COPPER)



%100 BAKIR PA66

KOD CODE	ALMAN NORM	FRANSIZ NORM	F BOYUTLAR	L BOYUTLAR	KUTU ADET BOX PIECES	FİYAT (TÜRK LİRASI)
STM-IY-0,50			8	12	1000	0,315
STM-IY-0,75			8	14	1000	0,315
STM-IY-1,0			8	14	1000	0,315
STM-IY-1,5			8	14	1000	0,345
STM-IY-2,5			8	14	500	0,438
STM-IY-4,0			10	17	500	0,724
STM-IY-6,0			12	20	250	0,981
STM-IY-10			12	22	100	1,240
STM-IY-16			12	24	100	1,760
STM-IY-25			16	28	50	3,030
STM-IY-35			16	30	50	3,650
STM-IY-50			20	36	25	6,950
STM-IY-70			20	37	25	9,400

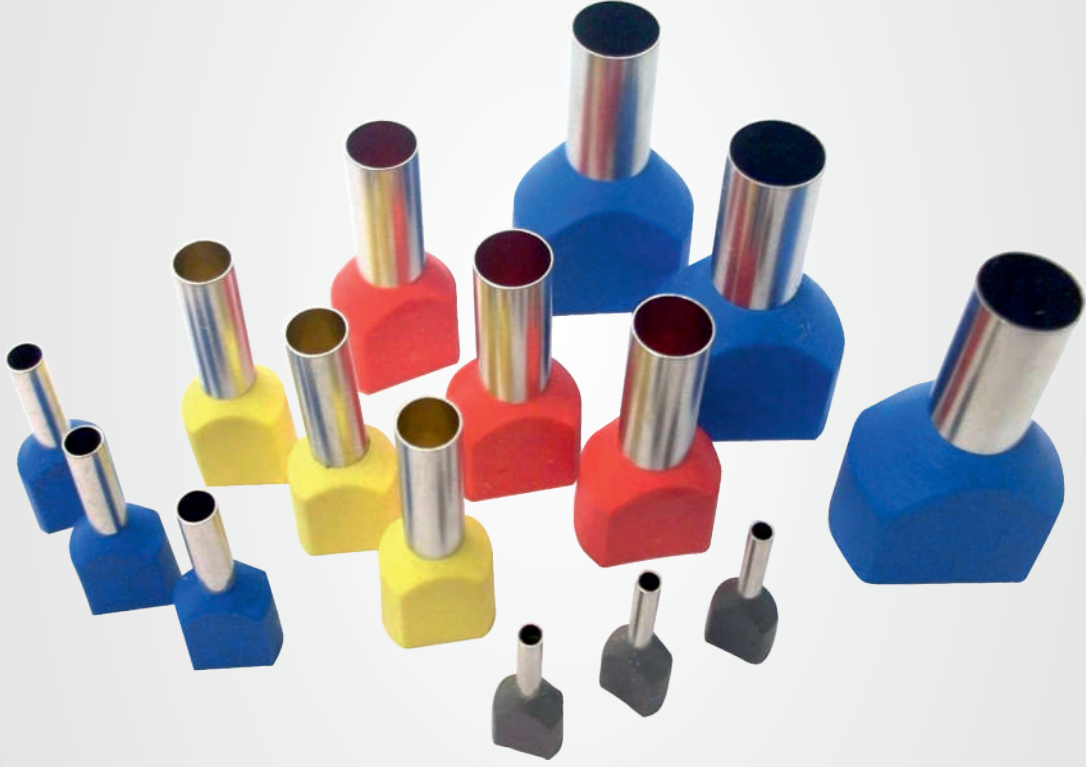





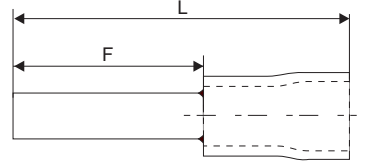











STANDART ÇİFT GİRİŞLİ İZOLELİ YÜKSÜKLERİ (BAKIR)

STANDARD DOUBLE ENTRY INSULATED CABLE THREADS (COPPER)

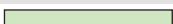

%100 BAKIR PA66

KOD CODE	ALMAN NORM	FRANSIZ NORM	F BOYUTLAR	L BOYUTLAR	KUTU ADET BOX PIECES	FİYAT (TÜRK LİRASI)
STM-CY-0,50			8	14	1000	0,555
STM-CY-0,75			8	14	500	0,582
STM-CY-1,0			8	14	500	0,621
STM-CY-1,5			8	14	500	0,752
STM-CY-2,5			10	14	250	1,224
STM-CY-4,0			12	17	200	1,408
STM-CY-6,0			14	20	100	1,744
STM-CY-10			14	27	100	2,782
STM-CY-16			14	31	50	3,358



YUVARLAK TİP İZOLELİ KABLO PABUCLARI ROUND TYPE INSULATED CABLE LUGS

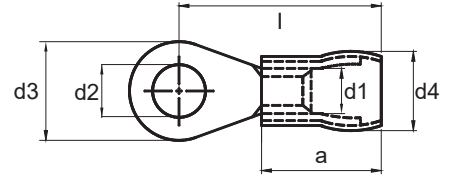

KOD CODE	RENK COLOR	KABLO KESİT CABLE SECTION	CİVATA ÖLÇÜSÜ BOLT SIZE	BOYUTLAR / DİMENSIYON						KUTU ADET BOX PİECES	FİYAT (TÜRK LİRASI)
				d2	d3	l	d1	d4	a		
SYU - 301		0.50 - 1.50 mm ²	M3	3.2	6.0	16.0	1.6	4.0	10.0	200	1,428
SYU - 401			M4	4.3	8.0	17.0	1.6	4.0	10.0	200	1,485
SYU - 501			M5	5.3	10.0	18.0	1.6	4.0	10.0	200	1,499
SYU - 601			M6	6.5	10.0	18.0	1.6	4.0	10.0	200	2,355
SYU - 801			M8	8,4	14.0	22.0	1.6	4.0	10.0	200	2,427





KOD CODE	RENK COLOR	KABLO KESİT CABLE SECTION	CİVATA ÖLÇÜSÜ BOLT SIZE	BOYUTLAR / DİMENSIYON						KUTU ADET BOX PİECES	FİYAT (TÜRK LİRASI)
				d2	d3	l	d1	d4	a		
SYU - 302		1.50 - 2.50 mm ²	M3	3.2	6.0	16.0	2.3	4.5	10.0	200	1,821
SYU - 402			M4	4.3	8.0	17.0	2.3	4.5	10.0	200	1,821
SYU - 502			M5	5.3	10.0	19.0	2.3	4.5	10.0	200	1,853
SYU - 602			M6	6.5	11.0	20.0	2.3	4.5	10.0	200	2,635
SYU - 802			M8	8,4	14.0	22.0	2.3	4.5	10.0	200	2,639
SYU - 1002			M10	10.5	15.0	22.0	2.3	4.5	10.0	200	2,643



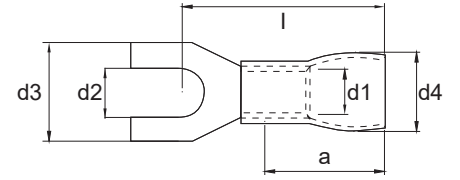

KOD CODE	RENK COLOR	KABLO KESİT CABLE SECTION	CİVATA ÖLÇÜSÜ BOLT SIZE	BOYUTLAR / DİMENSIYON						KUTU ADET BOX PİECES	FİYAT (TÜRK LİRASI)
				d2	d3	l	d1	d4	a		
SYU - 406		4.00 - 6.00 mm ²	M4	4.3	8.6	21.0	3.6	6.3	13.0	100	3,835
SYU - 506			M5	5.3	10.0	22.0	3.6	6.3	13.0	100	3,835
SYU - 606			M6	6.5	11.0	22.5	3.6	6.3	13.0	100	4,312
SYU - 806			M8	8,4	14.0	26.0	3.6	6.3	13.0	100	5,482
SYU - 1006			M10	10.5	18.0	28.0	3.6	6.3	13.0	100	5,547
SYU - 1206			M12	13.0	18.0	28.0	3.6	6.3	13.0	100	5,655





ÇATAL TİP İZOLELİ KABLO PABUCLARI FORK TYPE INSULATED CABLE LUGS



KOD CODE	RENK COLOR	KABLO KESİT CABLE SECTION	CİVATA ÖLÇÜSÜ BOLT SIZE	BOYUTLAR / DİMENSIYONLAR						KUTU ADET BOX PIECES	FİYAT (TÜRK LİRASI)
				d2	d3	l	d1	d4	a		
SÇU - 3001		0.50 - 1.50 mm ²	M3	3.2	6.0	16.0	1.6	4.0	10.0	200	1,301
SÇU - 4001			M4	4.3	8.0	17.0	1.6	4.0	10.0	200	1,324
SÇU - 5001			M5	5.3	10.0	18.0	1.6	4.0	10.0	200	1,409
SÇU - 6001			M6	6.5	11.0	20.0	1.6	4.0	10.0	200	1,595

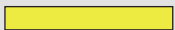

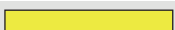
KOD CODE	RENK COLOR	KABLO KESİT CABLE SECTION	CİVATA ÖLÇÜSÜ BOLT SIZE	BOYUTLAR / DİMENSIYONLAR						KUTU ADET BOX PIECES	FİYAT (TÜRK LİRASI)
				d2	d3	l	d1	d4	a		
SÇU - 3002		1.50 - 2.50 mm ²	M3	3.2	5.5	18.0	2.3	4.5	10.0	200	1,463
SÇU - 4002			M4	4.3	6.8	17.0	2.3	4.5	10.0	200	1,502
SÇU - 5002			M5	5.3	10.0	19.0	2.3	4.5	10.0	200	1,528
SÇU - 6002			M6	6.5	11.0	21.0	2.3	4.5	10.0	200	2,054

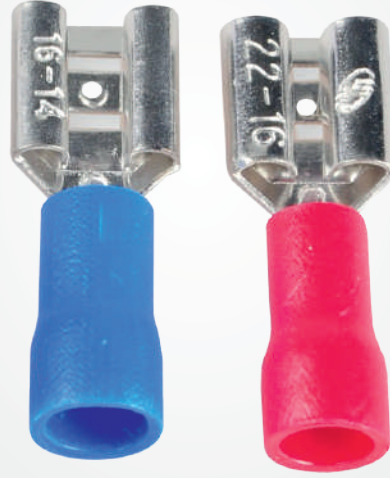

KOD CODE	RENK COLOR	KABLO KESİT CABLE SECTION	CİVATA ÖLÇÜSÜ BOLT SIZE	BOYUTLAR / DİMENSIYONLAR						KUTU ADET BOX PIECES	FİYAT (TÜRK LİRASI)
				d2	d3	l	d1	d4	a		
SÇU - 4006		4.00 - 6.00 mm ²	M4	4.3	8.0	21.0	3.6	6.3	13.0	100	3,382
SÇU - 5006			M5	5.3	10.0	22.0	3.6	6.3	13.0	100	3,467
SÇU - 6006			M6	6.5	11.0	23.0	3.6	6.3	13.0	100	4,594
SÇU - 8006			M8	8.4	14.0	26.0	3.6	6.3	13.0	100	5,265

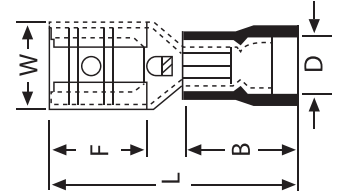

DİŞİ FASTON TİP İZOLELİ KABLO UÇLARI FEMALE FASTON TYPE INSULATED CABLE ENDS



KOD CODE	RENK COLOR	KABLO KESİT CABLE SECTION	SOKET GEN. SOCKET WIDTH	BOYUTLAR / DİMENSIYONLAR					KUTU ADET BOX PIECES	FİYAT (TÜRK LİRASI)
				W	F	L	B	D		
SFD - 1288		0.50 - 1.50 mm ²	0.8x2.80	3.2	6.5	19.0	10.5	3.8	200	1,647
SFD - 1488			0.8x4.75	5.0	6.4	19.4	10.5	3.8	200	1,647
SFD - 1638			0.8x6.35	6.6	7.5	20.8	10.5	3.8	200	1,907

KOD CODE	RENK COLOR	KABLO KESİT CABLE SECTION	SOKET GEN. SOCKET WIDTH	BOYUTLAR / DİMENSIYONLAR					KUTU ADET BOX PIECES	FİYAT (TÜRK LİRASI)
				W	F	L	B	D		
SFD - 2288		1.50 - 2.50 mm ²	0.8x2.80	3.2	6.5	19.0	10.5	4.7	200	2,013
SFD - 2488			0.8x4.75	5.0	6.4	19.4	10.5	4.7	200	2,195
SFD - 2638			0.8x6.35	6.6	7.5	20.8	10.5	4.7	200	2,384



KOD CODE	RENK COLOR	KABLO KESİT CABLE SECTION	SOKET GEN. SOCKET WIDTH	BOYUTLAR / DİMENSIYONLAR					KUTU ADET BOX PIECES	FİYAT (TÜRK LİRASI)
				W	F	L	B	D		
SFD - 5638		4.00 - 6.00 mm ²	0.8x2.80	3.2	6.5	19.0	10.5	3.8	200	2,609





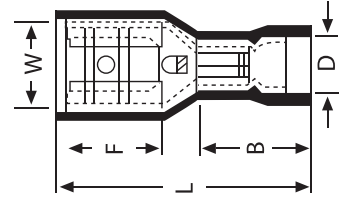

TAM İZOLELİ DİŞİ FASTON TİP KABLO UÇLARI

FULLY INSULATED FEMALE FASTON TYPE CABLE ENDS



KOD CODE	RENK COLOR	KABLO KESİT CABLE SECTION	SOKET GEN. SOCKET WIDTH	BOYUTLAR / DİMENİONS					KUTU ADET BOX PIECES	FİYAT (TÜRK LİRASI)
				W	F	L	B	D		
SFFD - 1288		0.50 - 1.50 mm ²	0.8x2.80	3.2	6.5	19.0	10.5	3.8	200	2,214
SFFD - 1488			0.8x4.75	5.0	6.4	20.5	10.5	3.8	200	2,214
SFFD - 1638			0.8x6.35	6.6	7.5	21.8	10.5	3.8	200	2,257



KOD CODE	RENK COLOR	KABLO KESİT CABLE SECTION	SOKET GEN. SOCKET WIDTH	BOYUTLAR / DİMENİONS					KUTU ADET BOX PIECES	FİYAT (TÜRK LİRASI)
				W	F	L	B	D		
SFFD - 2288		1.50 - 2.50 mm ²	0.8x2.80	3.2	6.5	20.0	10.5	4.7	200	2,449
SFFD - 2488			0.8x4.75	5.0	6.4	20.2	10.5	4.7	200	2,449
SFFD - 2638			0.8x6.35	6.6	7.5	22.2	10.5	4.7	200	2,257



KOD CODE	RENK COLOR	KABLO KESİT CABLE SECTION	SOKET GEN. SOCKET WIDTH	BOYUTLAR / DİMENİONS					KUTU ADET BOX PIECES	FİYAT (TÜRK LİRASI)
				W	F	L	B	D		
SFFD - 5638		4.00 - 6.00 mm ²	0.8x6.35	6.6	7.5	24.2	12.5	6.2	100	3,207

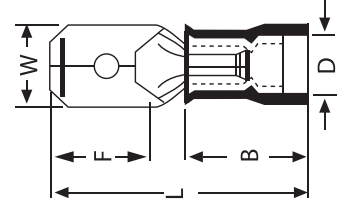

ERKEK FASTON TİP TERMİNAL UÇLARI MALE FASTON TYPE TERMINAL TERMINALS



KOD CODE	RENK COLOR	KABLO KESİT CABLE SECTION	SOKET GEN. SOCKET WIDTH	BOYUTLAR / DİMENSIYONLAR					KUTU ADET BOX PIECES	FİYAT (TÜRK LİRASI)
				W	F	L	B	D		
SFE - 1288		0.50 - 1.50 mm ²	0.8x2.80	2.8	6.5	19.2	10.5	3.8	200	1,313
SFE - 1488			0.8x4.75	4.8	6.7	19.8	10.5	3.8	200	1,313
SFE - 1638			0.8x6.35	6.35	6.35	21.8	10.5	3.8	200	1,567

KOD CODE	RENK COLOR	KABLO KESİT CABLE SECTION	SOKET GEN. SOCKET WIDTH	BOYUTLAR / DİMENSIYONLAR					KUTU ADET BOX PIECES	FİYAT (TÜRK LİRASI)
				W	F	L	B	D		
SFE - 2288		1.50 - 2.50 mm ²	0.8x2.80	2.8	6.7	19.8	10.5	4.7	200	1,313
SFE - 2488			0.8x4.75	4.8	6.7	19.8	10.5	4.7	200	1,313
SFE - 2638			0.8x6.35	6.35	7.7	21.8	10.5	4.7	200	1,712

KOD CODE	RENK COLOR	KABLO KESİT CABLE SECTION	SOKET GEN. SOCKET WIDTH	BOYUTLAR / DİMENSIYONLAR					KUTU ADET BOX PIECES	FİYAT (TÜRK LİRASI)
				W	F	L	B	D		
SFE - 5638		4.00 - 6.00 mm ²	0.8x6.35	6.6	7.7	24.8	13.0	6.2	200	2,048



ISI İLE DARALAN SİYAH MAKARONLAR

HEAT SHREDDING BLACK PASTA

KOD CODE	ÖLÇÜ MEASUREMENT	RENK COLOR	AMBALAJ (m) / MAKARA PACKAGING (m) / Reel	FİYAT (DOLAR)
SDM 1,5	1,5	Siyah	200	0,146 \$
SDM 2,0	2,0	Siyah	200	0,173 \$
SDM 2,4	2,4	Siyah	200	0,173 \$
SDM 2,5	2,5	Siyah	200	0,225 \$
SDM 3,0	3,0	Siyah	200	0,241 \$
SDM 3,2	3,2	Siyah	200	0,241 \$
SDM 3,5	3,5	Siyah	200	0,255 \$
SDM 4,0	4,0	Siyah	200	0,303 \$
SDM 4,5	4,5	Siyah	200	0,345 \$
SDM 4,8	4,8	Siyah	200	0,345 \$
SDM 5,0	5,0	Siyah	200	0,375 \$
SDM 6,0	6,0	Siyah	200	0,435 \$
SDM 6,4	6,4	Siyah	200	0,435 \$
SDM 7,0	7,0	Siyah	100	0,525 \$
SDM 8,0	8,0	Siyah	100	0,525 \$
SDM 9,5	9,5	Siyah	100	0,525 \$
SDM 10,0	10,0	Siyah	100	0,585 \$
SDM 12,7	12,7	Siyah	100	0,675 \$
SDM 13,0	13,0	Siyah	100	0,723 \$
SDM 14,0	14,0	Siyah	100	0,841 \$
SDM 16,0	16,0	Siyah	100	1,125 \$
SDM 18,0	18,0	Siyah	100	1,471 \$
SDM 19,1	19,1	Siyah	100	1,471 \$
SDM 20,0	20,0	Siyah	100	1,875 \$
SDM 22,0	22,0	Siyah	100	2,325 \$
SDM 25,0	25,4	Siyah	50	2,495 \$
SDM 30,0	30,0	Siyah	50	3,225 \$
SDM 32,0	32,0	Siyah	50	3,225 \$
SDM 35,0	35,0	Siyah	50	4,055 \$
SDM 38,0	38,0	Siyah	50	4,509 \$
SDM 40,0	40,0	Siyah	50	4,509 \$
SDM 51,0	51,0	Siyah	25	5,709 \$
SDM 60,0	60,0	Siyah	25	7,655 \$
SDM 70,0	70,0	Siyah	25	10,25 \$
SDM 80,0	80,0	Siyah	25	11,25 \$

6-16 mm YÜKSÜK SIKMA PENSESİ

6-16 mm SPRING PLIERS



KOD CODE	AÇIKLAMA EXPLANATION	KUTU ADET BOX PIECES	FİYAT (DOLAR)
YAC-6	6-16 mm Yüksük Sıkma Pensesi	1	85,00 \$

0,8-6 mm YÜKSÜK SIKMA PENSESİ

0,8-6 mm SPRING PLIERS



KOD CODE	AÇIKLAMA EXPLANATION	KUTU ADET BOX PIECES	FİYAT (DOLAR)
YAC-8	0,80-6 mm Yüksük Sıkma Pensesi	1	105,00 \$

10-120 SKP SIKMA PENSESİ

10-120 SKP CRIMP PLIERS



KOD CODE	AÇIKLAMA EXPLANATION	KUTU ADET BOX PIECES	FİYAT (DOLAR)
SKP CK 06	10-120 Skp Sıkma Pensesi	1	195,00 \$

16-300 HİDROLİK SKP SIKMA PENSESİ (ÇANTAL SET)

16-300 HYDRAULIC SKP CRIMP PLIERS (SET WITH BAG)



KOD CODE	AÇIKLAMA EXPLANATION	KUTU ADET BOX PIECES	FİYAT (DOLAR)
SKP HD 300	10-300 Hidrolik Skp Sıkma Pensesi	1	240,00 \$

6-50 mm MEKANİK SKP SIKMA PENSESİ

6-50 mm MECHANICAL SKP CRIMPING PLIERS

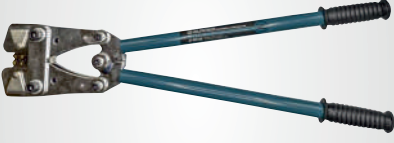

KOD CODE	AÇIKLAMA EXPLANATION	KUTU ADET BOX PIECES	FİYAT (DOLAR)
CK 05	6-50 mm SKP Sıkma Pensesi	1	100,00 \$

KABLO KESME MAKASI

CABLE CUTTING SCISSORS



KOD CODE	AÇIKLAMA EXPLANATION	KUTU ADET BOX PIECES	FİYAT (DOLAR)
TC 100	Max. 1x150 NYAF 120mm ²	1	96,00 \$

KABLO KESME MAKASI

CABLE CUTTING SCISSORS



KOD CODE	AÇIKLAMA EXPLANATION	KUTU ADET BOX PIECES	FİYAT (DOLAR)
TC 250	Max. 3x70+50 NYY 240mm ²	1	165,00 \$

PANO İÇİ TERMOSTATLAR

THERMOSTATS IN THE PANEL



KOD CODE	AÇIKLAMA EXPLANATION	KUTU ADET BOX PIECES	FİYAT (TÜRK LİRASI)
STM-26 I	0-60 Pano Isıtma için (Ray Montaj)	10	260,00
STM-26 S	0-10 Pano Sog için (Ray Montaj)	10	260,00

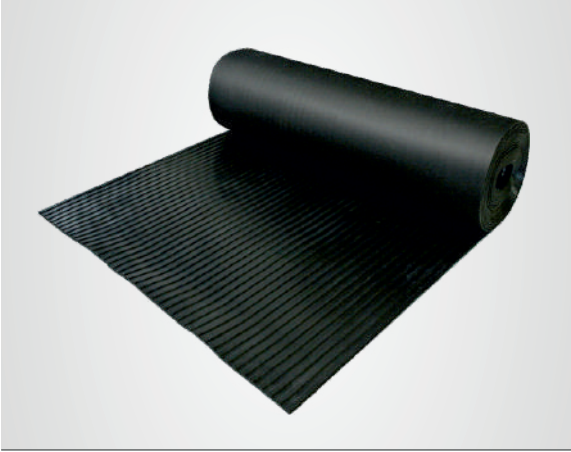

İZOLE HALILAR INSULATED CARPET

KOD CODE	AÇIKLAMA EXPLANATION	KUTU ADET BOX PIECES	FİYAT (TÜRK LİRASI)
STM IZL 1	1-6 KW - 2mm	1	460,00
STM IZL 15	15 KW - 3mm	1	680,00
STM IZL 30	30 KW - 4mm	1	920,00
STM IZL 40	40 KW - 5mm	1	1090,00



ALÜMİNYUM ÖLÜM TEHLİKE LEVHASI ALUMINUM DEATH HAZARD BOARD

KOD CODE	AÇIKLAMA EXPLANATION	KUTU ADET BOX PIECES	FİYAT (TÜRK LİRASI)
STM ALM	Alüminyum Levha (14x21 cm)	150	39,00



OPAK KAPAKLI ABS PANOLAR ABS BOARDS WITH OPAQUE COVER

KOD CODE	AÇIKLAMA EXPLANATION	KUTU ADET BOX PIECES	FİYAT (TÜRK LİRASI)
STM 203012	200 x 300 x 120 ABS PANO	1	575,00
STM 253515	250 x 350 x 150 ABS PANO	1	795,00
STM 304016	300 x 400 x 165 ABS PANO	1	950,00
STM 406020	400 x 600 x 200 ABS PANO	1	1690,00
STM 506023	500 x 600 x 230 ABS PANO	1	2630,00
STM 507025	500 x 700 x 250 ABS PANO	1	3315,00





Tarih	Not:
__/__/__	
__/__/__	
__/__/__	
__/__/__	
__/__/__	
__/__/__	
__/__/__	
__/__/__	
__/__/__	
__/__/__	
__/__/__	
__/__/__	
__/__/__	
__/__/__	
__/__/__	
__/__/__	
__/__/__	
__/__/__	
__/__/__	
__/__/__	
__/__/__	
__/__/__	
__/__/__	
__/__/__	
__/__/__	
__/__/__	
__/__/__	
__/__/__	
__/__/__	
__/__/__	
__/__/__	
__/__/__	
__/__/__	
__/__/__	
__/__/__	
__/__/__	
__/__/__	
__/__/__	
__/__/__	
__/__/__	
__/__/__	
__/__/__	

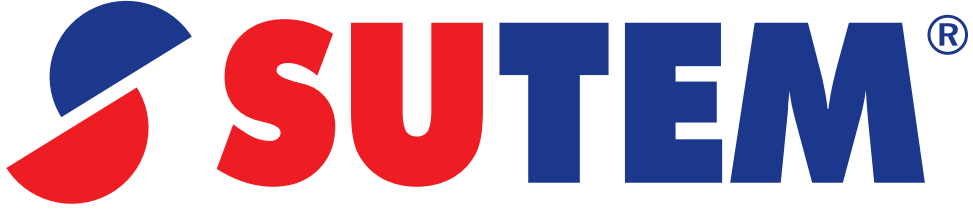

for perfect connections



18. Yıl



MERKEZ

Emekyemez Mah. Tenha Sk. No: 8/A
Karaköy / Beyoğlu - İSTANBUL
Tel: +90 212 238 54 14

info@sutemelektrik.com



FABRİKA

Des Sanayi Sitesi A-12 Blok 108. Sokak No:26
Dudullu OSB / Ümraniye - İSTANBUL

fabrika@sutemelektrik.com



www.sutemelektrik.com