

**STANDART TİP KABLO BAĞI**

| Malzeme Kodu | En (mm) | Boy (mm) | Max. Bağ. Çapı (mm) | Min. Açma Kuvveti (kg) | Kuyruk Tipi | Paket İçi Adet | Koli İçi Adet | Birim Fiyat (TL) |
|--------------|---------|----------|---------------------|------------------------|-------------|----------------|---------------|------------------|
|--------------|---------|----------|---------------------|------------------------|-------------|----------------|---------------|------------------|

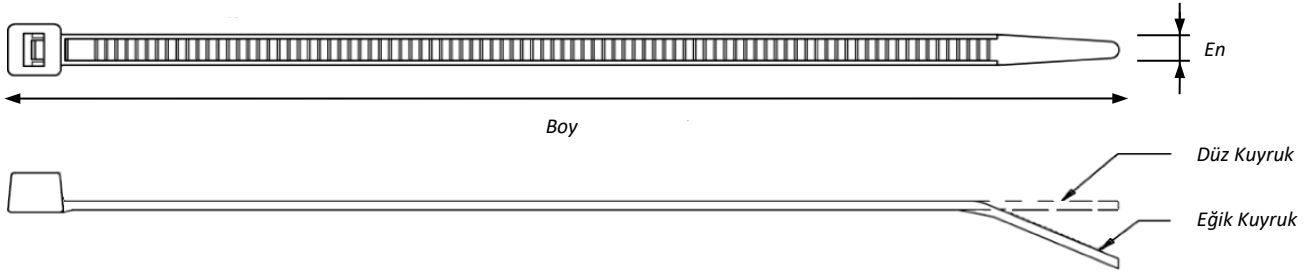

|           |     |     |     |    |      |       |        |       |
|-----------|-----|-----|-----|----|------|-------|--------|-------|
| EB.02.202 | 2,5 | 100 | 22  | 12 | Eğik | 1.000 | 60.000 | 0,170 |
| EB.12.212 | 2,5 | 140 | 35  | 12 | Eğik | 100   | 35.000 | 0,250 |
| EB.13.213 | 2,5 | 200 | 54  | 12 | Eğik | 100   | 25.000 | 0,360 |
| EB.23.223 | 3,6 | 100 | 21  | 18 | Eğik | 250   | 30.000 | 0,310 |
| EB.03.203 | 3,6 | 150 | 36  | 18 | Eğik | 100   | 25.000 | 0,410 |
| EB.04.204 | 3,6 | 205 | 54  | 18 | Eğik | 100   | 20.000 | 0,535 |
| EB.09.209 | 3,6 | 250 | 68  | 18 | Eğik | 100   | 18.000 | 0,660 |
| EB.10.210 | 3,6 | 300 | 81  | 18 | Düz  | 100   | 15.000 | 0,800 |
| EB.11.211 | 3,6 | 370 | 102 | 18 | Düz  | 100   | 12.000 | 1,050 |
| EB.14.214 | 4,8 | 200 | 50  | 25 | Eğik | 100   | 12.000 | 0,750 |
| EB.06.206 | 4,8 | 250 | 63  | 25 | Eğik | 100   | 12.000 | 0,940 |
| EB.05.205 | 4,8 | 300 | 80  | 25 | Düz  | 100   | 11.000 | 1,145 |
| EB.25.225 | 4,8 | 350 | 98  | 25 | Düz  | 100   | 9.000  | 1,305 |
| EB.16.216 | 4,8 | 400 | 109 | 25 | Düz  | 100   | 8.000  | 1,520 |
| EB.26.226 | 4,8 | 450 | 125 | 25 | Düz  | 100   | 6.000  | 1,800 |
| EB.07.207 | 8   | 250 | 62  | 55 | Düz  | 100   | 6.000  | 1,840 |
| EB.18.218 | 8   | 300 | 75  | 55 | Düz  | 100   | 5.000  | 2,370 |
| EB.19.219 | 8   | 380 | 105 | 55 | Düz  | 100   | 5.000  | 2,580 |
| EB.21.221 | 8   | 450 | 124 | 55 | Düz  | 100   | 3.500  | 2,970 |
| EB.15.215 | 8   | 550 | 160 | 55 | Düz  | 100   | 2.500  | 3,900 |
| EB.24.224 | 8   | 750 | 220 | 55 | Düz  | 100   | 2.000  | 6,230 |
| EB.17.217 | 9   | 762 | 225 | 80 | Düz  | 100   | 1.500  | 8,280 |
| EB.22.222 | 9   | 940 | 290 | 80 | Düz  | 100   | 1.500  | 9,570 |

**KABLO BAĞLARI İLE İLGİLİ TEMEL BİLGİLER**

Hammadde : NYLON 6.6 (UL94 V-2)

Çalışma Sıcaklığı : -40 °C ila +85 °C

Renk : Natürel ve siyah renkler standart, diğer renkler isteğe bağlı üretilir.

RoHS Direktifine uygun imal edilmiştir ve halojen içermez.

Petrol ürünlerine, organik asitlere ve greslere mükemmel dirençlidir.

Minimum açma kuvvetleri, Amerikan Askeri Standardına (MIL-S-23190 E) uygun veya daha yüksektir.

Açık hava kullanımına uygun UV dayanımlı ve yüksek sıcaklığa dayanımlı kablo bağları da isteğe bağlı üretilir.

NYLON 6.6 higroskopik bir hammadde olduğu için kablo bağları ortamdaki nem oranına göre yapılarındaki suyu tutar veya bırakır. Malzemenin nem oranı çekme kuvvetini ve sertliğini etkiler. Ürünlerin ideal nem oranını koruması için delik poşetli ürünlerin alınmaması ve poşetin kullanım esnasında açılması tavsiye edilir.



## ÇİFT KİLİTLİ KABLO BAĞI

| Malzeme Kodu   | En (mm) | Boy (mm) | Max. Bağlama Çapı (mm) | Min. Açma Kuvveti (kg) | Paket İçi Adet | Koli İçi Adet | Birim Fiyat (TL) |
|--|---------|----------|------------------------|------------------------|----------------|---------------|------------------|
|  |         |          |                        |                        |                |               |                  |
| CB.48.165  | 4,8     | 165      | 35                     | 25                     | 100            | 15.000        | 0,810            |
| CB.50.300  | 4,8     | 300      | 74                     | 25                     | 100            | 10.000        | 1,220            |

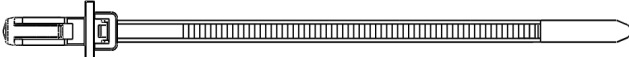

## DELİKLİ KABLO BAĞI

| Malzeme Kodu   | En (mm) | Boy (mm) | Delik Çapı (mm) | Max. Bağ. Çapı (mm) | Min. Açma Kuvveti (kg) | Paket İçi Adet | Koli İçi Adet | Birim Fiyat (TL) |
|--|---------|----------|-----------------|---------------------|------------------------|----------------|---------------|------------------|
|  |         |          |                 |                     |                        |                |               |                  |
| PV.40.205  | 4       | 205      | Ø 5,5           | 50                  | 22                     | 100            | 12.500        | 0,950            |

## DÜBELLİ KABLO BAĞI

| Malzeme Kodu   | En (mm) | Boy (mm) | Delik Çapı (mm) | Max. Panel Kalınlığı (mm) | Max. Bağ. Çapı (mm) | Min. Açma Kuvveti (kg) | Paket İçi Adet | Koli İçi Adet | Birim Fiyat (TL) |
|--|---------|----------|-----------------|---------------------------|---------------------|------------------------|----------------|---------------|------------------|
|   |         |          |                 |                           |                     |                        |                |               |                  |
| DK.03.303  | 3,6     | 110      | Ø 6,4           | 2                         | 21                  | 18                     | 100            | 10.000        | 0,680            |
| DK.11.311  | 4,8     | 100      | Ø 6,4           | 2,5                       | 17                  | 25                     | 100            | 12.500        | 0,750            |
| DK.08.308  | 4,8     | 150      | Ø 6,4           | 2                         | 30                  | 25                     | 100            | 10.000        | 0,850            |
| DK.13.313  | 4,8     | 150      | Ø 8,5           | 2                         | 30                  | 25                     | 100            | 9.000         | 0,900            |
| DK.09.309  | 4,8     | 200      | Ø 6,4           | 2                         | 45                  | 25                     | 100            | 8.000         | 1,000            |
|   |         |          |                 |                           |                     |                        |                |               |                  |
| DK.10.310  | 3,6     | 110      | Ø 6,4           | 2                         | 20                  | 18                     | 100            | 20.000        | 0,510            |
| DK.04.304  | 3,6     | 115      | Ø 6,4           | 4                         | 21                  | 18                     | 100            | 15.000        | 0,680            |
|    |         |          |                 |                           |                     |                        |                |               |                  |
| DK.06.306  | 3,6     | 165      | Ø 4,8           | 2,5                       | 32                  | 18                     | 100            | 25.000        | 0,610            |
| DK.07.307  | 3,6     | 166      | Ø 4,8           | 3,5                       | 32                  | 18                     | 100            | 25.000        | 0,610            |

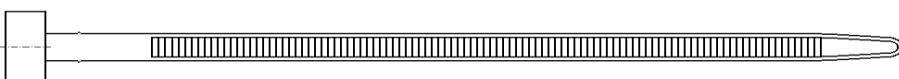
## TOKALI KABLO BAĞI

| Malzeme Kodu   | En (mm) | Boy (mm) | Max. Bağlama Çapı (mm) | Min. Açma Kuvveti (kg) | Paket İçi Adet | Koli İçi Adet | Birim Fiyat (TL) |
|--|---------|----------|------------------------|------------------------|----------------|---------------|------------------|
|  |         |          |                        |                        |                |               |                  |
| EF.03.803  | 6       | 235      | 63                     | 45                     | 250            | 5.000         | 3,450            |
|  |         |          |                        |                        |                |               |                  |
| EF.05.805  | 7,6     | 380      | 110                    | 50                     | 50             | 3.000         | 4,120            |

## BONCUK KELEPÇE

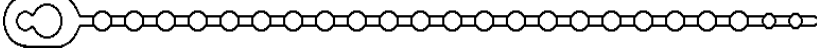
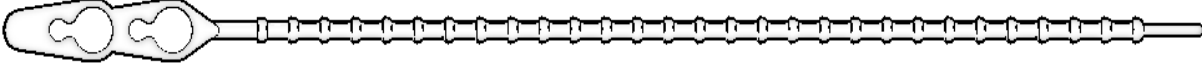
| Malzeme Kodu   | En (mm) | Boy (mm) | Max. Bağlama Çapı (mm) | Min. Açma Kuvveti (kg) | Paket İçi Adet | Koli İçi Adet | Birim Fiyat (TL) |
|--|---------|----------|------------------------|------------------------|----------------|---------------|------------------|
|   |         |          |                        |                        |                |               |                  |
| EA.01.101  | 2       | 105      | 25                     | 5                      | 1.000          | 50.000        | 0,280            |
| EA.02.102  | 3,5     | 165      | 45                     | 7                      | 500            | 25.000        | 0,590            |
|  |         |          |                        |                        |                |               |                  |
| EA.04.104  | 3,5     | 235      | 60                     | 14                     | 100            | 15.000        | 0,940            |

## BURMA KELEPÇE

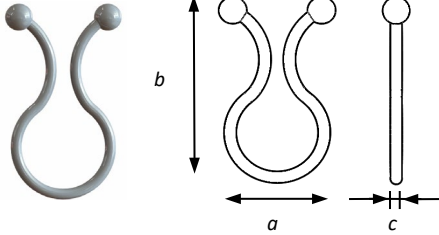
| Malzeme Kodu  | a (mm) | b (mm) | c (mm) | Max. Bağlama Çapı (mm) | Paket İçi Adet | Koli İçi Adet | Birim Fiyat (TL) |
|---|--------|--------|--------|------------------------|----------------|---------------|------------------|
|  |        |        |        |                        |                |               |                  |
| EA.05.105   | 8,5    | 21     | 1,8    | 4,5                    | 500            | 50.000        | 0,320            |
| EA.07.107   | 12     | 25     | 2      | 7                      | 500            | 45.000        | 0,380            |
| EA.10.110   | 16     | 30     | 2,1    | 10,5                   | 500            | 35.000        | 0,450            |
| EA.14.114   | 20     | 36     | 2,1    | 14                     | 500            | 30.000        | 0,480            |
| EA.17.117   | 23     | 40     | 2,2    | 17                     | 500            | 15.000        | 0,520            |

## YAPIŞKAN KROŞE

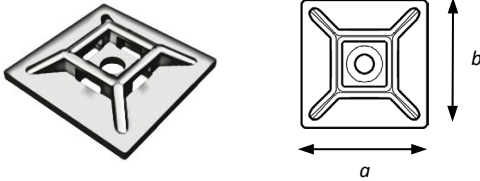
| Malzeme Kodu   | a (mm) | b (mm) | Delik Çapı (mm) | Max. Kablo Bağı Eni (mm) | Paket İçi Adet | Koli İçi Adet | Birim Fiyat (TL) |
|--|--------|--------|-----------------|--------------------------|----------------|---------------|------------------|
|  |        |        |                 |                          |                |               |                  |
| EK.01.1001   | 20     | 20     | Ø 3,2           | 3,6                      | 100            | 20.000        | 0,820            |
| EK.03.1003   | 28     | 28     | Ø 4,3           | 4,8                      | 100            | 9.000         | 1,400            |

## VİDALI KROŞE

| Malzeme Kodu   | a (mm) | b (mm) | Delik Çapı (mm) | Max. Kablo Bağı Eni (mm) | Paket İçi Adet | Koli İçi Adet | Birim Fiyat (TL) |
|--|--------|--------|-----------------|--------------------------|----------------|---------------|------------------|
|  |        |        |                 |                          |                |               |                  |
| EK.06.1006 - EK.02.1002  |        |        |                 | EK.13.1013               |                |               |                  |
| EK.06.1006   | 10     | 17     | Ø 3,7           | 4,8                      | 250            | 30.000        | 0,640            |
| EK.02.1002   | 17     | 23     | Ø 6,5           | 8                        | 250            | 12.500        | 0,810            |
| EK.13.1013   | 15     | 30     | Ø 4,8           | 8                        | 100            | 10.000        | 1,000            |

## KABLO KLİPSİ

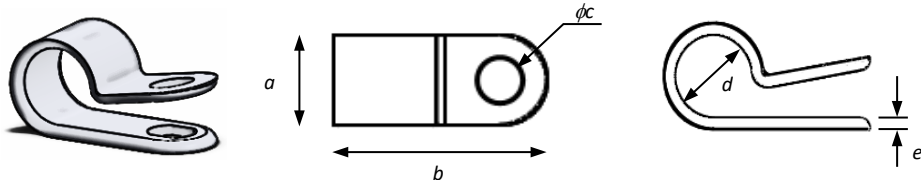
| Malzeme Kodu   | a (mm) | b (mm) | c (mm) | d (mm)      | e (mm) | Paket İçi Adet | Koli İçi Adet | Birim Fiyat (TL) |
|--|--------|--------|--------|-------------|--------|----------------|---------------|------------------|
|  |        |        |        |             |        |                |               |                  |
| EK.61.1061   | 10     | 17,5   | M5     | 3,2 (1/8")  | 1,3    | 100            | 30.000        | 0,380            |
| EK.63.1063   | 10     | 20,8   | M5     | 6,4 (1/4")  | 1,3    | 100            | 20.000        | 0,520            |
| EK.64.1064   | 10     | 22,8   | M5     | 7,9 (5/16") | 1,3    | 100            | 15.000        | 0,600            |
| EK.65.1065   | 10     | 24     | M5     | 10,9 (3/8") | 1,3    | 100            | 15.000        | 0,660            |
| EK.75.1075   | 12,3   | 26,3   | M5     | 9,5 (3/8")  | 1,5    | 100            | 10.000        | 0,970            |

## DUBELLİ KROŞE

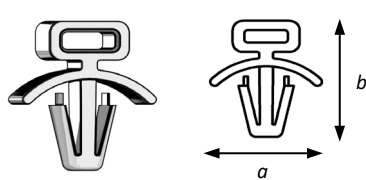
| Malzeme Kodu   | a (mm) | b (mm) | Delik Çapı (mm) | Max. Kablo Bağı Eni (mm) | Paket İçi Adet | Koli İçi Adet | Birim Fiyat (TL) |
|--|--------|--------|-----------------|--------------------------|----------------|---------------|------------------|
|  |        |        |                 |                          |                |               |                  |
| EK.04.1004   | 17,8   | 16,3   | Ø 6             | 4,8                      | 500            | 40.000        | 0,480            |

## DUVAR & KANAL KROŞELERİ

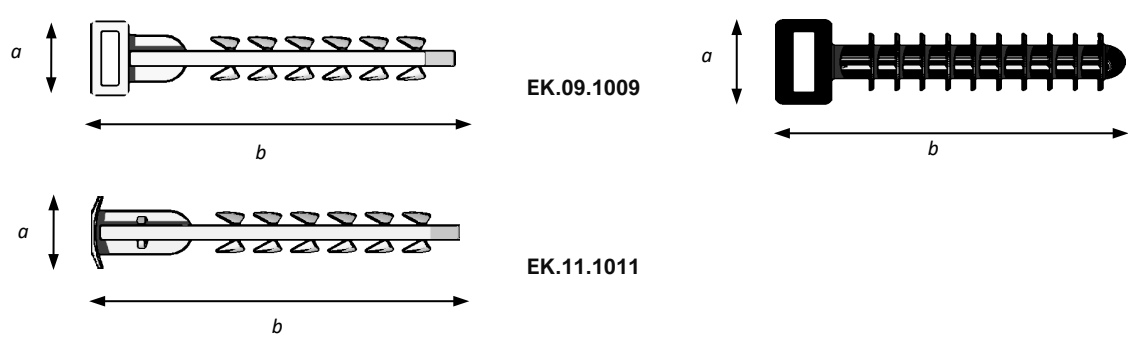
| Malzeme Kodu   | a (mm) | b (mm) | Delik Çapı (mm) | Max. Kablo Bağı Eni (mm) | Paket İçi Adet | Koli İçi Adet | Birim Fiyat (TL) |
|--|--------|--------|-----------------|--------------------------|----------------|---------------|------------------|
|  |        |        |                 |                          |                |               |                  |
| EK.09.1009   | 9,6    | 46,5   | Ø 6             | 4,8                      | 250            | 17.500        | 0,820            |
| EK.17.1017   | 13,2   | 42,8   | Ø 8             | 8                        | 250            | 9.000         | 0,950            |
| EK.11.1011   | 10     | 47,6   | Ø 6             | -                        | 250            | 17.500        | 0,790            |

## OMEGA KLİPSİ

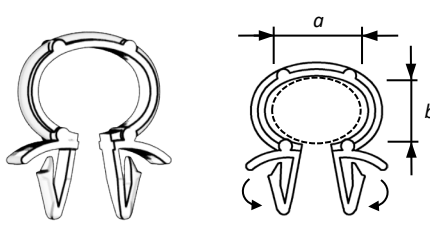
| Malzeme Kodu   | Yükseklik (mm) | Genişlik (mm) | Delik Çapı (mm) | a (mm) | b (mm) | Paket İçi Adet | Koli İçi Adet | Birim Fiyat (TL) |
|--|----------------|---------------|-----------------|--------|--------|----------------|---------------|------------------|
|  |                |               |                 |        |        |                |               |                  |
| EK.34.1034   | 23,5           | 20            | Ø 6,5           | 13,5   | 9,8    | 250            | 20.000        | 1,500            |

**DUBELLİ KABLO TUTUCU**

| Malzeme Kodu | Yükseklik (mm) | Genişlik (mm) | Delik Çapı (mm)                      | a (mm)       | b (mm) | Paket İçi Adet | Koli İçi Adet | Birim Fiyat (TL) |
|--------------|----------------|---------------|--------------------------------------|--------------|--------|----------------|---------------|------------------|
|              |                |               |                                      |              |        |                |               |                  |
| EK.10.1010   |                |               | EK.27.1027 - EK.28.1028 - EK.30.1030 |              |        | EK.18.1018     |               |                  |
| EK.10.1010   | 23             | 15,3          | Ø 4,8                                | 11,3         | 6,5    | 250            | 30.000        | 0,600            |
| EK.27.1027   | 27,3           | 15,2          | Ø 4,8                                | 11,2         | 9,8    | 250            | 30.000        | 0,700            |
| EK.28.1028   | 36,3           | 15,2          | Ø 4,8                                | 11,2         | 19     | 250            | 20.000        | 0,840            |
| EK.30.1030   | 29             | 28            | Ø 4,8                                | 22,4         | 12,4   | 250            | 18.000        | 0,850            |
| EK.18.1018   | 22             | 15,5          | Ø 4,8                                | 11,6         | 7      | 250            | 30.000        | 0,620            |
|              |                |               |                                      |              |        |                |               |                  |
| EK.24.1024   |                |               | EK.29.1029                           |              |        |                |               |                  |
| EK.24.1024   | 20             | 20            | Ø 4,8                                | Ø 8          | -      | 250            | 25.000        | 1,300            |
| EK.29.1029   | 32             | 23            | Ø 6,4                                | Ø 7,4 - 10,2 | -      | 100            | 12.500        | 1,300            |



**BURGULU KROŞE**

| Malzeme Kodu | a (mm) | b (mm) | Delik Çapı (mm) | Max. Bağlama Çapı (mm) | Paket İçi Adet | Koli İçi Adet | Birim Fiyat (TL) |
|--------------|--------|--------|-----------------|------------------------|----------------|---------------|------------------|
|              |        |        |                 |                        |                |               |                  |
| EK.50.1050   | 28     | 3,6    | Ø 4,8           | 10,5                   | 100            | 24.000        | 0,525            |
| EK.51.1051   | 32,7   | 3,6    | Ø 4,8           | 14                     | 100            | 20.000        | 0,540            |
| EK.52.1052   | 32     | 31,4   | Ø 4,8           | 13,5                   | 100            | 9.000         | 1,250            |

**KART TUTUCU**

| Malzeme Kodu | Yükseklik (mm) | Genişlik (mm) | Üst Delik Çapı (mm) | Alt Delik Çapı (mm) | a (mm) | Paket İçi Adet          | Koli İçi Adet | Birim Fiyat (TL) |
|--------------|----------------|---------------|---------------------|---------------------|--------|-------------------------|---------------|------------------|
|              |                |               |                     |                     |        |                         |               |                  |
| EK.70.1070   |                |               | EK.08.1008          |                     |        | EK.71.1071 - EK.72.1072 |               |                  |
| EK.08.1008   | 24,5           | 15            | Ø 4                 | Ø 4,5               | 6,2    | 500                     | 40.000        | 1,600            |
| EK.70.1070   | 27             | 14,4          | Ø 3                 | Ø 4,8               | 13,9   | 250                     | 40.000        | 0,700            |
| EK.71.1071   | 26,5           | 15,3          | Ø 4                 | Ø 4,8               | 9,2    | 250                     | 40.000        | 0,700            |
| EK.72.1072   | 30             | 15,3          | Ø 4                 | Ø 4,8               | 12,6   | 250                     | 40.000        | 0,750            |

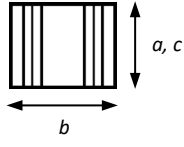
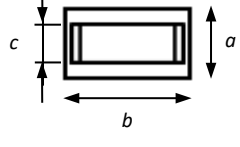
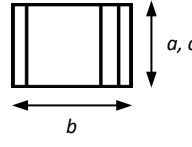
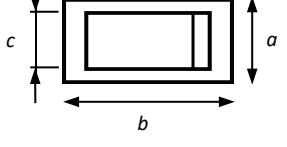
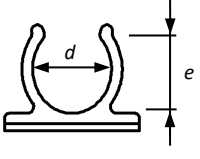
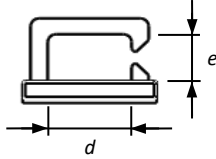
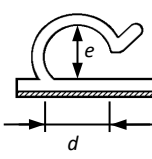
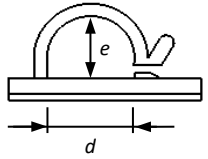
**YAPIŞKAN KLİPS**

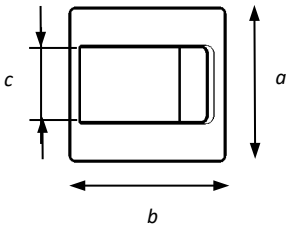
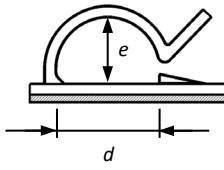
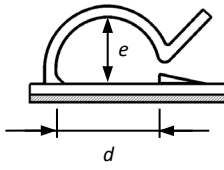
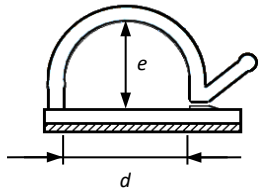
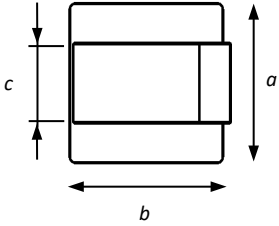
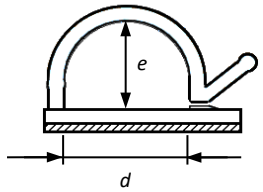
| Malzeme Kodu  | a (mm)  | b (mm)  | c (mm)  | d (mm)  | e (mm)   | Paket İçi Adet  | Koli İçi Adet  | Birim Fiyat (TL)  |
|---|---|---|---|---|--|---|--|---|
|    |    |    |   |    |     |      |  |  |
| <b>EK.25.1025</b>   |   | <b>EK.26.1026</b>   |   | <b>EK.16.1016</b>   |  | <b>EK.19.1019</b>   |  |   |
| EK.25.1025  | 13  | 15  | 13  | 8,7   | 8,7  | 250   | 25.000   | 1,050   |
| EK.26.1026  | 10  | 16  | 5   | 9,7   | 5,8  | 250   | 25.000   | 0,900   |
| EK.16.1016  | 13  | 16  | 13  | 6,1   | 5,2  | 250   | 28.000   | 0,900   |
| EK.19.1019  | 13  | 25  | 8,7   | 11  | 7  | 100   | 20.000   | 1,190   |
|  |  |  |  |  |  |  |  |   |
| <b>EK.05.1005</b>   |   | <b>EK.07.1007</b>   |   |   |  |   |  |   |
| EK.05.1005  | 25  | 25  | 12,7  | 12,5  | 8  | 100   | 10.000   | 1,800   |
| EK.07.1007  | 25  | 25  | 12,7  | 16,5  | 12   | 100   | 7.000  | 1,920   |

**PLASTİK KAPAK & PUL**

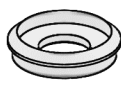
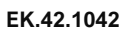
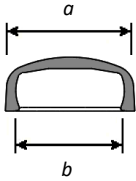
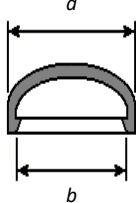
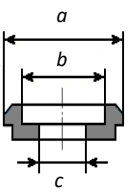
| Malzeme Kodu | Yükseklik (mm)  | a (mm)  | b (mm)  | c (mm)  | Paket İçi Adet  | Koli İçi Adet   | Birim Fiyat (TL) |
|--------------|---|---|---|---|---|---|------------------|
| EK.40.1040   |  |  |  |  |  |  |                  |
| EK.41.1041   |   |   |   | <b>EK.40.1040</b>   | <b>EK.41.1041</b>   | <b>EK.42.1042</b>   |                  |
| EK.40.1040   | 5   | Ø 12  | Ø 10  | -   | 500   | 35.000  | 0,350            |
| EK.41.1041   | 5,6   | Ø 14  | Ø 11,5  | -   | 500   | 35.000  | 0,350            |
| EK.42.1042   | 3,2   | Ø 12  | Ø 9,5   | Ø 5,2   | 500   | 50.000  | 0,350            |

**PLASTİK TAPA**

| Malzeme Kodu | a (mm) | b (mm) | c (mm) | Delik Çapı (mm) | Paket İçi Adet | Koli İçi Adet | Birim Fiyat (TL) |
|--------------|--------|--------|--------|-----------------|----------------|---------------|------------------|
| EK.43.1043   | 2,7    | 7,8    | Ø 14,4 | Ø 8             | 500            | 60.000        | 0,650            |
| EK.44.1044   | 0,8    | 4,2    | Ø 13,9 | Ø 11            | 500            | 75.000        | 0,650            |

EK.43.1043

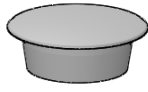

EK.44.1044

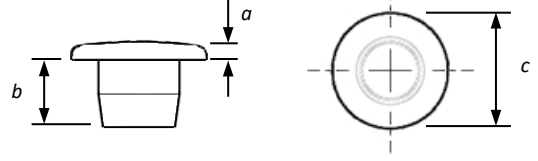

**KABLO BAĞI ETİKETİ**

| Malzeme Kodu | a (mm) | b (mm) | Etiket Boyu (mm) | Etiket Eni (mm) | Max. Kablo Bağı Eni (mm) | Paket İçi Adet | Koli İçi Adet | Birim Fiyat (TL) |
|--------------|--------|--------|------------------|-----------------|--------------------------|----------------|---------------|------------------|
| ET.07.907    | 10     | 35     | 7                | 32              | 8                        | 100            | 12.500        | 1,400            |
| ET.06.906    | 20     | 45     | 17               | 42              | 8                        | 100            | 6.000         | 2,800            |

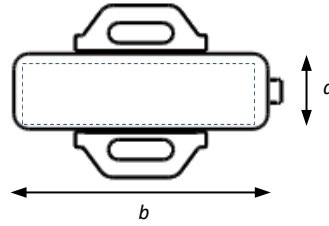
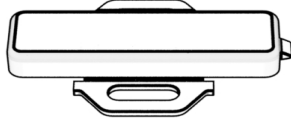

**YAPIŞKAN PANO ETİKETİ**

| Malzeme Kodu | a (mm) | b (mm) | Etiket Boyu (mm) | Etiket Eni (mm) | Paket İçi Adet | Koli İçi Adet | Birim Fiyat (TL) |
|--------------|--------|--------|------------------|-----------------|----------------|---------------|------------------|
| ET.08.908    | 17     | 30     | 14,4             | 27,5            | 100            | 12.000        | 1,860            |
| ET.03.903    | 17     | 50     | 15               | 49              | 50             | 6.000         | 2,470            |
| ET.04.904    | 17     | 75     | 15               | 72              | 25             | 5.000         | 3,370            |

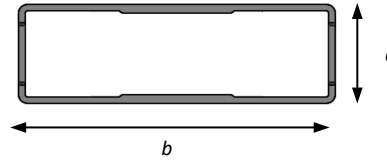

**BUTON ETİKETİ**

| Malzeme Kodu | a (mm) | b (mm) | Etiket Boyu (mm) | Etiket Eni (mm) | c (mm) | Paket İçi Adet | Koli İçi Adet | Birim Fiyat (TL) |
|--------------|--------|--------|------------------|-----------------|--------|----------------|---------------|------------------|
| ET.11.911    | 40     | 30     | 8                | 26              | 22     | 60             | 7.500         | 2,310            |
| ET.12.912    | 50     | 30     | 18               | 26              | 22     | 60             | 6.000         | 2,380            |

